



OAKLAND CITY COUNCIL

ORDINANCE No. _____ C.M.S.

ORDINANCE: (1) REPEALING CURRENT OAKLAND MUNICIPAL CODE CHAPTER 15.12, THE OAKLAND FIRE CODE; (2) MAKING FINDINGS TO SUBSTANTIATE MODIFICATIONS TO CALIFORNIA BUILDING CODES AND STANDARDS DUE TO LOCAL CLIMATIC, GEOLOGICAL OR TOPOGRAPHICAL CONDITIONS; (3) ADOPTING AND MAKING LOCAL AMENDMENTS TO THE 2022 EDITION OF THE CALIFORNIA MODEL BUILDING CODE, CALIFORNIA CODE OF REGULATIONS TITLE 24, PART 9 (ALSO REFERRED TO AS THE “CALIFORNIA FIRE CODE”); (4) RECODIFYING SAID CODE AS OAKLAND MUNICIPAL CODE CHAPTER 15.12, THE OAKLAND FIRE CODE; AND (5) ADOPTING CALIFORNIA ENVIRONMENTAL QUALITY ACT EXEMPTION FINDINGS

WHEREAS, the State of California adopts a new California Building Standards Code every three years which goes into effect throughout the State 180 days after publication. The California Building Standards Code is contained in Title 24 of the California Code of Regulations (CCR) and consists of several parts that are based upon model codes with amendments made by various State agencies. Part 9 of Title 24 contains the California Fire Code, the 2022 Edition of which will go into effect throughout California on January 1, 2023; and

WHEREAS, the City Council of the City of Oakland does hereby find that there is a need to enforce the most current edition of the California Fire Code, with local amendments thereof, as recited herein for regulating and controlling the design, erection, construction, enlargement, installation, alteration, repair, relocation, removal, use and occupancy, demolition, conversion, height and area, location and maintenance, and quality of materials of and structures and plumbing, mechanical, electrical, and fire suppression systems and certain equipment within the corporate boundaries of the City of Oakland; and

WHEREAS, the City Council of the City of Oakland further hereby finds that there is a need to provide for the issuance of permits and the collection of fees therefore and for penalties for the violation thereof, and for superseding other ordinances, in part or in whole, which are in conflict therewith; and

WHEREAS, prior to adoption, amendments to the state codes may be incorporated by the local jurisdiction if they can be justified on the basis of a local climatic, local geological, and/or local topographical condition which affect the jurisdiction; and

WHEREAS, as in past State building standards code adoption cycles, in this ordinance the City of Oakland repeals its existing Oakland Amendments to the 2019 Edition of the California Fire Code Codes (2019 Fire Code Amendments) in their entirety and enacts new Oakland Fire Code Amendments of the 2022 Edition of the California Fire Code (2022 Oakland Fire Code Amendments); and

WHEREAS, the City Council of the City of Oakland further hereby determines that the adoption of local administrative and non-administrative amendments of the most current editions of the California Fire Code, which provide for certain changes, supplements, and deletions thereof as recited herein, will satisfy these needs by providing for minimum standards to safeguard life, limb, property, and public welfare; and

WHEREAS, California Health & Safety Code section 17958.7 provides that before making any changes or modifications to the California Building Standards Code and any other applicable provisions published by the State Building Standards Commission, the governing body must make an express finding that each such change or modification is reasonably necessary because of specified local conditions, and the findings must be filed with the State Building Standards Commission before the local changes or modifications can go into effect; and

WHEREAS, the City Council does herewith find that the City of Oakland has certain climatic, geologic, topographical features and that can have a deleterious effect on emergency services such as fire protection and emergency medical services; and

WHEREAS, after a duly noticed public meeting on November 29, 2022, the Community and Economic Development Committee voted to recommend the proposal to the City Council; and

WHEREAS, the City Council held a duly noticed public hearing on December 6th and 20th, 2022, to consider the proposed amendments and all interested parties were provided an ample opportunity to participate in said hearing and express their views; and

WHEREAS, the proposed Ordinance is exempt from the California Environmental Quality Act (CEQA) pursuant to CEQA Guidelines sections 15378, 15061(b)(3) (General Rule), 15301 (Existing Facilities), 15303 (New Construction or Conversion of Small Structures), and 15183 (Projects Consistent with a Community Plan, General Plan, or Zoning); and

WHEREAS, the City Council of the City of Oakland hereby finds and determines that due to local climatic, geologic and topographic conditions, as provided below, that modifications and changes to the current 2022 California Fire Code are reasonably necessary to provide specific and greater protection of life, health and property; and

WHEREAS, the City Council further hereby finds and determines that all proposed modifications are reasonably necessary based upon local climatic, geologic and topographic conditions as set forth below:

1. **The City of Oakland is situated near several known major faults, each capable of generating earthquakes of significant magnitude.** These include the South Hayward Fault, the North Hayward, the San Andreas, and the Rodgers Creek Faults. These faults are subject to becoming active at any time, the City of Oakland is particularly vulnerable to devastation should such an earthquake occur. The potential effects of earthquake activity include isolating the City of Oakland from the surrounding area and restricting or eliminating internal circulation due to the potential for collapsing of highway overpasses and underpasses, along with other bridges in the City, or a landslide, and the potential for vertical movement rendering surface travel unduly burdensome or impossible.
2. **The seasonal climatic conditions during late summer and early fall pose serious challenges to the Oakland Fire Department in controlling and fighting wild land urban interface fires.** The hot, dry weather typical of this area in fire season coupled with strong Diablo Winds can result in wildfires that threaten the City of Oakland. While some code requirements, such as fire-resistive roof classification, have a direct bearing on fire survival in a wild land fire situation, others, such as residential fire sprinklers, may also have a positive effect. In dry climate on low humidity days, materials are much more easily ignited. More fires are likely to occur and any fire, once started, can expand rapidly. Residential fire sprinklers can arrest a fire starting within a structure before it spreads to adjacent brush and structures.
3. **The City of Oakland is bisected by Interstates 80, 880 and 580. Interstates 80 and 880 are designated by the California Highway Patrol as approved transportation routes for highly toxic and radioactive materials.** The potential for release or threatened release of a hazardous material along one of these routes is highly possible given the volume transported daily. Incidents of this nature will normally require all available emergency response personnel to prevent injury and loss of life and to prevent, as far as practicable, property loss. Emergency personnel responding to such aforementioned incidents may be unduly impeded and delayed in accomplishing an emergency response. Potential risk to the protection of life and public safety and, in particular, residents and occupants in structures without the protection of automatic fire sprinklers.

4. **The topography of Oakland presents problems in delivery of emergency services, including fire protection.** Hilly terrain has narrow, winding roads with limited access for emergency response and residential egress, preventing rapid access and orderly evacuation. Much of these hills are covered with highly non-fire-resistive natural vegetation. In addition to access and evacuation problems, the terrain makes delivery of water extremely difficult. Some hill areas are served by water pump systems subject to failure in fire, high winds, earthquake and other power failure situations. Due to the topography in much of the City of Oakland, roadway condition, angle of approach or departure, steeply sloping roadways and grades are common.

5. **The City's geography and topography include natural boundaries such as the east bay hills, Lake Merritt, the Oakland Estuary and San Francisco bay.** These geographic boundaries and topographical features necessitate local provisions for fire safety command center design and specifications for certain new construction. Further the presence of the Hayward earthquake fault reduces the ability of adjoining jurisdictions to provide timely mutual response for building fires in the event a natural or manmade disaster occurs and local resources are unable to adequately respond.

6. **There is expansive soil in many areas of the Oakland Hills that retain ground water from severe rainstorms.** This produces a condition wherein the moisture content of the soil is sufficient that roadways become damaged due to soil expansion and shrinkage. All-weather paved surfaces capable of supporting the imposed loads of fire apparatus are necessary to ensure access of emergency response personnel. These roadways, approach angles, steep slopes and grades can also make it difficult for fire apparatus and other emergency vehicles to access a site. It is therefore essential that these roadway accesses be provided with proper all-weather paved surfaces, angle of approach, grades and gate access; and

WHEREAS, City staff recommends that the City Council adopt the 2022 California Fire Code and to add local code requirements, which among other things will:

1. Add reference to the 2021 International Existing Building Code to define the relative hazards in different occupancy classifications.
2. Require that buildings four (4) or more stories in height or forty-five thousand (45,000) square feet or more total building area and all buildings classified as high-rise buildings by the California Building Code and Group I-2 occupancies having occupied floors located more than 75 feet above the lowest level of fire department vehicle access, have a fire command center.
3. Increase requirements for safe Emergency personnel communication in buildings which due to age, location or infrastructure that cannot meet the current standard.
4. Add standards for fire protection systems and fire department access where accessory dwelling units are to comply when the addition is greater than five hundred (500) square feet to increase protection for the safety of occupants, surrounding structures and Emergency Personnel.
5. Add safety measure requirements to properties in the Very High Severity Zone that are using alternative means of energy in areas historically known to be challenged by

- topography, increase in dry vegetation due to drought and restrictive roads creating delayed response times for emergency vehicle access response.
6. Add safety measure requirements for the rescue of occupants and for safe emergency operations in homes within the High Fire Severity Zone that are built on slopes greater than 15%; and

NOW, THEREFORE, THE COUNCIL OF THE CITY OF OAKLAND DOES ORDAIN AS FOLLOWS:

SECTION 1. Recitals. The Council of the City of Oakland hereby determines that the preceding recitals are true and correct and hereby adopts and incorporates them into this ordinance.

SECTION 2. Repeal of Chapter 15.12 Oakland Municipal Code (Oakland Fire Code). Chapter 15.12 of the Oakland Municipal Code is hereby repealed in its entirety, and all provisions within any article, part, section, subsection, sentence, clause, or phrase of other ordinances that conflict within or between or among the provisions of this ordinance or the most current editions of the California Fire Code are hereby superseded. The 2019 Oakland Fire Code Amendments being repealed were enacted by Ordinance No. 13577 C.M.S., which is available on the City of Oakland's website.

SECTION 3. Enactment of Local Amendments to the 2022 Editions of the California Fire Code (Amendments to Oakland Municipal Code Chapter 15.12). The 2022 Oakland Fire Code Amendments are hereby enacted. The 2022 Oakland Amendments being enacted amend Oakland Municipal Code Chapter 15.12, and are contained in **Exhibit A** entitled "Oakland Municipal Code Chapter 15.12 – Oakland Fire Code," attached hereto and incorporated as if set forth fully herein. The most current editions of the California Fire Code, as amended herein, shall be the governing fire code for the City of Oakland from and following January 1, 2023, or on the date the ordinance is filed with the California Building Standards Commission, whichever date is later.

SECTION 4. CEQA. The City Council finds that this ordinance is exempt pursuant to California Environmental Quality Act Guidelines sections 15378, 15061(b)(3) (General Rule), 15301 (Existing Facilities), 15303 (New Construction or Conversion of Small Structures), and 15183 (Projects Consistent with a Community Plan, General Plan, or Zoning).

SECTION 5. Continuation of Actions under Prior Code. Nothing contained in this ordinance shall be construed as abating any action now pending under or by virtue of any ordinance of the City of Oakland hereby repealed, nor shall this ordinance be construed as discontinuing, abating, modifying or altering any penalties accruing, or to accrue, or as waiving any right of the City under any such ordinance.

SECTION 6. Severability. If any section, subsection, sentence, clause or phrase of this ordinance is for any reason held by a court of competent jurisdiction to be invalid, such a decision shall not affect the validity of the remaining portions of this ordinance. Such section, subsection, sentence, clause or phrase, instead, shall be superseded and replaced by the corresponding provisions, if any exist, of Title 24 of the California Code of Regulations. The City Council of the City of Oakland hereby declares that it would have passed this ordinance and each section or subsection, sentence, clause and phrase thereof, irrespective of the fact that any one or more sections, subsections, sentences, clauses or phrases be declared invalid.

SECTION 7. Implementation Date. Notwithstanding the foregoing, the City of Oakland will not implement any provisions of this ordinance until it is filed with the California Building Standards Commission.

SECTION 8. Effective Date. Pursuant to Oakland Charter Section 216, this ordinance shall become effective on January 1, 2023, or on the date the ordinance is filed with the California Building Standards Commission, whichever date is later.

IN COUNCIL, OAKLAND, CALIFORNIA,

PASSED BY THE FOLLOWING VOTE:

AYES – FIFE, GALLO, KALB, KAPLAN, REID, TAYLOR, THAO AND
PRESIDENT FORTUNATO BAS

NOES –
ABSENT –
ABSTENTION –

ATTEST: _____
ASHA REED
City Clerk and Clerk of the Council of the
City of Oakland, California

Date of Attestation: _____

EXHIBIT A

OAKLAND MUNICIPAL CODE CHAPTER 15.12 - OAKLAND FIRE CODE

15.12.010 - 2022 California Fire Code is Adopted and Amended.

- A. The 2022 California Fire Code, including referenced National Fire Protection Association Standards and other standards as adopted by the California State Fire Marshal, is hereby adopted and made a part of this chapter as though fully set forth herein, subject to the modifications thereto set forth in this chapter.
- B. This chapter shall be known as the "Oakland Fire Code" and shall be referred to in this chapter as "this chapter," "this Code" or "the Oakland Fire Code."
- C. To the extent permitted by law, the Fire Chief may, at his/her sole discretion, revise requirements set forth in the Oakland Fire Code in specific instances due to climatic, geographic or topographic conditions.
- D. A copy of this Code is on file in the office of the City Clerk of the City of Oakland.

15.12.020 – Fire Prevention Bureau.

- A. Oakland Municipal Code Section 2.29.030 established the Fire Prevention Bureau within the Oakland Fire Department under the direction of the Fire Chief. The function of the Fire Prevention Bureau is to assist the Fire Chief in the administration and enforcement of the provisions of this code.
- B. References to the "Fire Marshal" or "Fire Code Official" in the California Fire Code shall mean the person in charge of the Fire Prevention Bureau as appointed by the Fire Chief.

15.12.030 - Oakland Amendments to the 2022 California Fire Code.

The following sections of the 2022 California Fire Code as adopted herein are hereby revised as noted by italicized terms including, but not limited to, *add*, *amend* or *delete*, as follows:

CHAPTER 1 - DIVISION II ADMINISTRATION PART 1 - GENERAL PROVISIONS

Section 101. Scope and General Requirements - *Amend Section 101 as follows:*

Amend: 101.1 Title. This Section 15.12.020 of Oakland Municipal Code Chapter 15.12 shall be known as the "Oakland Amendments to the 2022 California Fire Code," may be cited as such and will be referred to herein as "this Chapter," "this Code," or the "Oakland Fire Code."

Amend: 101.2 Scope. This code establishes regulations affecting or relating to structures, processes, premises and safeguards regarding:

1. The hazard of fire and explosion arising from the storage, handling or use of structures, materials or devices;
2. Conditions hazardous to life, property or public welfare in the occupancy of structures or premises;
3. Fire hazards in the structure or on the premises from occupancy or operation;
4. Matters related to the construction, extension, repair, alteration or removal of fire suppression or alarm systems; and
5. Conditions affecting the safety of fire fighters and emergency responders during emergency operations.

Amend: 101.2.1 Appendices. The following Appendices of the 2022 California Fire Code are adopted by the City of Oakland and made a part of the Oakland Fire Code.

Appendix	Title
Appendix - Chapter 4	Special Detailed Requirements Based on Use and Occupancy
Appendix B	Fire-Flow Requirements for Buildings
Appendix BB	Fire-Flow Requirements for Buildings
Appendix C	Fire Hydrant Locations and Distribution
Appendix CC	Fire Hydrant Locations and Distribution
Appendix D	Fire Apparatus Access Roads
Appendix E	Hazard Categories
Appendix F	Hazard Ranking
Appendix G	Cryogenic Fluids—Weight and Volume Equivalents
Appendix H	Hazardous Materials Plans and Hazardous Materials Inventory Statements
Appendix I	Fire Protection Systems—Noncompliant Conditions
Appendix K	Construction Requirements for Existing Ambulatory Care Facilities
Appendix M	High Rise Buildings - Retroactive Automatic Sprinkler Requirement
Appendix N	Indoor Trade Shows and Exhibits
Appendix O	Temporary Haunted Houses, Ghost Walks and Similar Amusement Uses

Add: 101.2.2 General Provision. Where any section of the 2022 California Fire Code or any other referenced codes, regulations or standards are amended by this Chapter, all provisions of such original codes, regulations or standards not so specifically amended shall remain in full force and effect. Notwithstanding the foregoing, in the

event provisions set forth herein conflict with any section of the 2022 California Fire Code or any other referenced codes, regulations or standards, the provisions of this Code shall prevail and control. Further, in the event that provisions set forth in this code conflict with provisions the City Charter, the City Charter shall prevail and control.

Failure to comply with any of the provisions of this Code, including failure to provide, obtain or maintain valid permits, certifications, tests, listings, affixed labeling, inspection approvals, or other conditions of permit; failure to repair, demolish, remove, abate vegetation hazards in the Very High Fire Severity Zone, or rehabilitate unsafe materials, appliances, fixtures, equipment or other property; or failure to prevent, restrain, correct, or abate conditions unsafe or hazardous for egress or fire protection or health due to inadequate maintenance, excess loading, dilapidation, or abandonment shall be and is declared to be prima facie evidence of an existing and continuing hazard to life or limb, property or public welfare.

Section 102. Applicability - Amend Section 102 as follows:

Amend: 102.1. Construction and design provisions. The construction and design provisions of this code shall apply to:

1. Structures, facilities and conditions arising after the adoption of this code.
2. Existing structures, facilities and conditions not legally in existence at the time of adoption of this code.
3. Existing structures, facilities and conditions when required in Chapter 11.
4. Existing structures, facilities and conditions which, in the opinion of the Fire Code Official, constitute a distinct hazard to life or property.

Add: 5. All materials, assemblies, appliances, fixtures, equipment, and installations thereof; all arrangements of occupancies, exits, aisles, stairs, and doors; all parapet walls, cornices, spires, towers, tanks, statuary, signage, structural members, appendages, and appurtenances thereto in buildings and structures regulated by the 2022 California Fire Code shall be so arranged, assembled, installed, maintained and of sufficient size and so protected as to reduce and minimize all egress, fire, safety, and health hazards.

Add: 6. The quality of all materials, assemblies, appliances, fixtures, and equipment; methods of connection, assembly, and installation; allowable stress, strain, deflection, rate and volume and velocity of flow, pressure, temperature, and opacity; and assumed loads and capacities to be used in the design and construction of all buildings and structures, plumbing and mechanical installations, and electrical systems shall be consistent with requirements of this Code and nationally recognized standards of quality and generally recognized and well-established methods of testing, design, installation, and construction. Testing, listing, and affixed labeling shall be prima facie evidence of conformity with approved standards for safety to life and limb, property, and public welfare.

Amend: 102.3 Change of use or occupancy. Changes shall not be made in the use or occupancy of any structure that would place the structure in a different division of the same group or occupancy or in a different group of occupancies, unless such structure is made to comply with the requirements of 2022 California Fire Code and the California Building Code. Subject to the approval of the Fire Code Official, the use or occupancy of an existing structure shall be allowed to be changed and the structure is allowed to be occupied for purposes in other groups without conforming to all of the requirements of this code and the California Building Code for those groups, provided the new or proposed use is less hazardous, based on life and fire risk, than the existing use.

When a new or proposed use of an existing structure is more hazardous than the existing use, based on life and fire risk, an automatic fire extinguishing system and associated fire protection systems shall be provided in the building or tenant space. Tenant spaces shall be separated from the remaining tenant spaces based on the type of Occupancy/Construction for non-sprinklered construction and in accordance with the CBC.

When a new or proposed use of an existing structure is less hazardous of an existing use, based on life and fire risk an automatic fire extinguishing system and associated fire protection systems shall be

provided to the occupancies referenced in Sections 904.1.1 through 904.1.7. of the 2021 International Existing Building Code.

Add: Table 102.3

Relative Hazard	Occupancy Classifications
1 (Highest Hazard)	H
2	I-2, I-3, I-4
3	A, E, I-1, M, R-1, R-2, R-4
4	B, F-1, R-3, S-1
5 (Lowest Hazard)	F-2, S-2, U

Changes in the same occupancy classification shall be handled by code bulletin

Amend: 102.8. Subjects not regulated by this code. Where no applicable standards or requirements are set forth in this code, or are contained within other laws, codes, regulations, ordinances or bylaws adopted by the jurisdiction, compliance with applicable standards of the National Fire Protection Association or other nationally recognized fire safety standards, as approved, shall be deemed as prima facie evidence of compliance with the intent of this code. Nothing herein shall derogate from the authority of the Fire code official to determine compliance with codes or standards for those activities or installations within the Fire code official's jurisdiction or responsibility. Further, unless expressly stated herein, this code is not intended to amend, repeal, or supersede provisions of any other codes, regulations, ordinances, or the Oakland City Charter, including, but not limited to, the demolition ordinance, earthquake damage abatement ordinance, dangerous building ordinance, creek protection ordinance, Planning Code and Building Maintenance Code.

Section 105. Permits - Amend Section 105 as follows:

Amend: 105.2 Application. Application for a permit required by this code shall be made to the Fire Code Official in such form and detail as prescribed by the Fire Code Official. Applications for permits shall be accompanied by such plans as prescribed by the Fire Code Official. An application for a permit shall be accompanied by a fee established by resolution of the city council.

Amend: 105.3.7 Information on the permit. The Fire Code Official shall issue all permits required by this code on an approved form furnished for that purpose. The permit shall contain a general description of the operation or occupancy and its location and any other information required by the Fire Code Official. Issued permits shall bear the signature of the Fire Code Official or other approved legal authorization.

Every permit shall also contain an agreement as follows which shall be executed by the permit holder as a condition of issuance:

"I hereby agree to save, defend, indemnify and keep harmless the City of Oakland and its officials, officers, employees, representatives, agents and volunteers from all actions, claims, demands, litigation, or proceedings, including those for attorneys' fees, against the City in consequence of the granting of this permit or from the use or occupancy of the public right-of-way, public easement, or any sidewalk, street or sub-sidewalk or otherwise by virtue thereof, and will in all things strictly comply with the conditions under which this permit is granted. I further certify that I am the owner of the property involved in this permit or that I am fully authorized by the owner to access the property and perform the work authorized by this permit."

Amend: 105.5.9 Compressed Gases. An operational permit is required for the storage, use, or handling, at normal temperatures and pressures (NTP), of compressed gases in excess of the amounts listed in Table

105.5.9, to install any piped distribution system for compressed gases, or to install a non-flammable medical gas manifold system. When the compressed gases in use or storage exceed the maximum amounts list in Table 105.5.9, a permit is required to install, repair, abandon, remove, place temporarily out of service, close or substantially modify a compressed gas system.

Amend: 105.5.11 Cryogenic fluids. An operational permit is required to produce, store, transport on site, use, handle or dispense cryogenic fluids in excess of the amounts listed in Table 105.5.11. See also Chapter 55.

Exception: Except where federal or state regulations apply and except for fuel systems of a vehicle a construction permit is required to install a cryogenic vessel or piping system for the storage or distribution of cryogens.

Amend: 105.5.18 Flammable and combustible liquids. An operational permit is required:

Amend: 10. To engage in the dispensing of liquid fuels into the fuel tanks of motor vehicles at commercial, industrial, governmental or manufacturing establishments in accordance with Section 5706.5.4 or to engage in on-demand mobile fueling operations in accordance with Section 5707.

Amend: 11. To utilize a site for the dispensing of liquid fuels from tank vehicles into the fuel tanks of motor vehicles, marine craft and other special equipment at commercial, industrial, governmental or manufacturing establishments in accordance with Section 5706.5.4 or, where required by the fire code official, to utilize a site for on-demand mobile fueling operations in accordance with Section 5707.

Add: 12. To store, handle or use Class IIIB liquids with a flashpoint of less than 500 degrees F in excess of 110 gallons.

Add: 13. To install, alter, remove, test, abandon, place temporarily out of service or otherwise dispose of any flammable or combustible liquid tank.

Add: 105.5.54 Additional operational permits. In addition to the permits required by Section 105.6, the following operational permits shall be obtained from the Fire Code Official:

1. **General use permit.** A general use permit for any activity or operation not specifically addressed in this article, which in the judgment of the Fire Code Official, is possible or likely to produce conditions hazardous to life or property.
2. **Occupancies, buildings, and uses.** An operational permit is required for various occupancies, buildings, and uses as established or modified by The City.

Add: 105.5.55 Fire Alarm or Sprinkler Monitoring System. No person shall install or cause to be installed any fire alarm system device designed to indicate a fire emergency without first obtaining a permit. Application and plans for such permit shall be made to the Fire Code Official in accordance with 106 of this code.

Amend: 106.2. Compressed gases. When the compressed gases in use or storage exceed the amounts listed in Table 105.5.9, a construction permit is required to install any piped distribution system for compressed gases, or to install a non-flammable medical gas manifold system, repair damage to, abandon, remove, place temporarily out of service, or close or substantially modify a compressed gas system.

Amend: 105.6.6 Fire alarm and detection systems and related equipment A construction permit is required for installation of or modification to fire alarm and detection systems or sprinkler monitoring system and related equipment. Maintenance performed in accordance with this code is not considered a modification.

Add: 105.6.25 Landscaping and irrigation. A construction permit is required to install or alter landscaping and irrigation in the Wildland Urban Interface Fire Areas (also known as High Fire Hazard Areas). See also Chapter 49.

Section 107. Fees - Amend Section 7 as follows:

Amend: 107.4 Work commencing before permit issuance. A person who commences any work, activity or operation regulated by this code before obtaining the necessary permits shall be subject to an additional

fee double the amount of the permit fee as established by the applicable governing authority, which shall be in addition to the required permit fees.

Add: 107.7 Fees for services; establishment; review. The Fire Code Official is authorized to collect fees for services established or modified by resolution of the City Council. The Fire Code Official shall review the fees charged for such services at least once annually and may, with the approval of the City Administrator, recommend changes to the council when the costs for such services make it appropriate.

Add: 107.8 False alarms or nuisance alarms. The Fire Code Official is authorized to assess a service charge, as set forth by resolution, against the person owning or responsible for an alarm system when a fire department response occurs per the City of Oakland Master Fee Schedule and for each subsequent false alarm or nuisance alarm thereafter, or against any person who intentionally, or in violation of the law reports, or causes to be reported, a false alarm or nuisance alarm to any department of the City of Oakland.

Section 109. Maintenance - Amend Section 109 as follows:

Amend: 109.3 Recordkeeping. Records of all system inspections, tests and maintenance required by the referenced standards shall be maintained on the premises for a minimum of three years or a different period of time where specified in this code or referenced standards and shall be electronically copied to the Fire Code Official by the company that performed the inspection, testing or maintenance in a manner prescribed by the Fire Code Official.

Section 111. Means of Appeals - Amend Section 111 as follows:

Amend: 111.1 Board of appeals established. In order to hear and decide appeals of orders, decisions, or determinations made by the Fire Code Official relative to the application and interpretation of non-administrative (technical) requirements of this Code, the property owner may request an administrative hearing or appeal in accordance with law. The request shall be filed in writing with the Fire Code Official and shall be accompanied with a fee as established by the Master Fee Schedule. The request for an administrative hearing or appeal shall contain the information provided under Section 109.4.

Amend: 111.2 Limitations on authority. An application for appeal shall be based on a claim that the intent of this code or rules legally adopted hereunder have been incorrectly interpreted, the provisions of this code do not fully apply, or an equivalent method of protection or safety is proposed. The person(s) hearing the appeal shall not have authority to waive requirements of this code.

Amend: 111.3 Qualifications. No person(s) hearing the appeal shall be an employee of the City of Oakland and shall be qualified by experience and training regarding fire explosions, hazardous conditions or fire protection systems, and building construction and other matters pertaining to the 2022 California Fire Code.

Add: 111.5 Procedures. The request for an administrative hearing or appeal shall contain the following information:

1. A brief statement setting forth the legal interest of the party or parties in the real property identified in the order, decision or determination made by the Fire Code Official;
2. A brief statement in ordinary and concise language of that (those) specific order(s), decision(s) or determination(s) protested;
3. A brief statement in ordinary and concise language, together with any material facts to support that contention that the intent of this code or the rules legally adopted hereunder have been incorrectly interpreted, the provisions of this code do not fully apply, or an equivalent method of protection or safety is proposed;
5. The signature of the property owner, and his or her mailing address; and
6. The verification (by declaration under penalty of perjury) of at least one person requesting a hearing as to the truth of the matters stated in the request for hearing.

The written request for an administrative hearing or appeal with the accompanying fee shall be received by the Fire Code Official within fourteen (14) calendar days from the date of the service of such order, decision or determination of the Fire Code Official.

As soon as practicable after receiving the request for administrative hearing, the Fire Code Official shall fix a date, time and place for the administrative hearing. Written notice of the time and place of the hearing shall be given to the appellant at least seven (7) calendar days prior to the date of the hearing.

The failure of the Fire Code Official to serve any person required herein to be served shall not invalidate any proceedings hereunder as to any other person duly served or relieve any such person from any duty or obligation imposed by the provisions of this Section.

Only those technical matters or issues specifically raised by the appellant in the Request for Hearing shall be considered.

Add: 111.6 Effect of hearing. Decisions on the administrative hearing or appeal in all instances shall be final and conclusive.

Add: 111.7 Review of administrative determination. The limitation period provided pursuant to California Code of Civil Procedure Section 1094.6 shall apply to all petitions filed seeking judicial review of administrative determinations made pursuant to Section 109.1.

Section 112. Violations - Amend Section 112 as follows:

Amend: 112.1 Unlawful acts. It shall be unlawful for a person, firm or corporation to erect, construct, alter, repair, remove, demolish or utilize a building, occupancy, premise(s), or system regulated by this code, or cause a public nuisance, potential fire or health hazard, or cause same to be done, in conflict with or in violation of any of the provisions of this code.

Add: 112.1.2 Blight or hazardous condition. Any commercially or residentially zoned parcel, lot or premise on which flammable or combustible materials as defined by this Code are openly stored or abandoned, causing blight or hazardous conditions, so as to constitute a potential fire or health hazard shall constitute a public nuisance and shall be ordered cleaned by the issuance of an Administrative Citation to the property owner in accordance with Section 107.1 of this Code.

Add: 112.1.3 Remuneration. In addition to the penalties provided by law, a violator shall be liable for such costs, expenses, disbursements, and attorneys' fees paid or incurred by the City or any of its officials, officers, representatives, employees, agents, volunteers, vendors, or third-party contractors in correction, abatement and prosecution of the violation.

Add: 112.3.3.1 Prosecution of violations. Any violation of this Code is deemed a public nuisance and a misdemeanor, but may be cited or charged, at the election of the enforcing officer or City Attorney or District Attorney, as infractions. Nothing in this Section shall prevent any other remedy at law. Each person shall be guilty of a separate offense for each and every day during a portion of which a violation of any provision of this Code is committed, continued, or permitted by such person.

Amend: 112.3.4 Unauthorized tampering. Signs, tags or seals posted or affixed by the Fire Code Official shall not be mutilated, destroyed or tampered with, or removed, without authorization from the Fire Code Official.

Amend: 112.4 Violation penalties. A person violates a provision of this code by failing to comply with any of the requirements thereof or who erects, installs, alters, repairs, or does work in violation of the approved construction documents or direction of the Fire Code Official or their designee, or of a permit or certificate used under the provisions of this code, is guilty of a misdemeanor offense as set forth in the Oakland Municipal Code. Each day that a violation continues after due notice has been served shall be deemed a separate offense. Cost recovery for this enforcement shall be provided per Section 112.4.3 of this code.

Amend: 112.4.2 Powers to Abate. The Fire Code Official or their designee is authorized to abate a fire or life hazard when necessary to protect life or property. This may include, but is not limited to, orders requiring the removal of flammable liquids, fireworks, hazardous electrical wiring, temporary closure of commercial occupancies, the extinguishment of unsafe or illegal fires and any other similar hazards, determining no

smoking areas, and ceasing operation of any type apparatus that poses an imminent danger to property or life.

Add: 112.4.3 Cost recovery. In addition to the enforcement and other proceedings referenced in Section 117 of this Code, the costs of any abatement action taken pursuant to this Code may be recovered by the City pursuant to the provisions of this Section and section 115. After performing the abatement work on the property in question, the City shall cause to be recorded with the County Recorder, a "prospective Notice of Special Assessment Lien." Such notice shall summarize the work performed, the cost and date of completion. The costs shall be imposed as a lien in conformance with Section 108 of this Code. The City may proceed to recover such costs in a civil lawsuit.

Add: 112.4.3.1 Notice of abatement orders, notices and actions. If notice has not already been given pursuant to Section 111.3, the Office of the Fire Code Official shall personally serve, or shall send one copy of the official notice to abate by regular mail, postage prepaid, to the person owning the parcel, including undeveloped land, on which the fire or dangerous condition is located, or to any person in control of said parcel, as such person's name and address appear on the current Office of the County Assessor, County of Alameda, State of California assessment roll. If such address is unknown to the City then notice shall be affected by physically posting such notice on the property itself. Service by mail shall be deemed completed at the time of deposit in the United States mail.

Section 114. Unsafe Buildings - Amend Section 114 as follows:

Add: Section 114.2.1 Unauthorized re-occupancy of unsafe buildings. No person shall reoccupy any building, which has been posted as specified in this subsection except for the purpose of securing same or making the required repairs or demolishing the building or structure, nor shall any person remove or deface any such notice so posted until the hazard/s has been abated.

Section 115. Judgment and Liens — Add Section 115 as follows:

Add: 115.1 Authority to lien. The cost incurred pursuant to Sections 104 and 107 of this Code in obtaining Real Property Ownership Reports and in razing or demolishing any fire or securing or cleaning any parcel and abating its associated fire hazard, or instituting a fire watch by action of the Fire Code Official or their designee, shall be a proper charge against the City Treasury and shall be paid from such. Re-inspections and administrative fees to ascertain Code compliance for overdue abatement of previously noticed or cited violations shall be charged against the owner. Fees shall be in the amount as currently described in the Master Fee Schedule. The Fire Code Official or their designee shall give the owner or other interested party of such premises a written notice and statement showing the itemized cost of such abatement, and requesting payment thereof. Alternatively, said charges may be directly collected in a civil lawsuit or by the filing and foreclosure of a lien.

Add: 115.2 Notice of hearing on lien. If the City chooses to pursue the cost recovery method outlined in Section 112.4.3, and the amount of such expenses as shown in such statement is not paid within ten (10) days after such notice, the City shall present written notice of those persons against whose property the City intends to file a lien to the City Council. The City Council shall forthwith, by resolution, fix a time and place for a public hearing on such notice. The City shall cause a copy of such notice to be served on the owner of the property not less than ten (10) days prior to the time fixed for such hearing. Mailing a copy of such notice to the owner of the property at the address listed in the most recent property ownership records provided to the City by the Office of the County Assessor, County of Alameda, State of California, as of the date the City causes notice to be mailed shall comprise proper service. Service shall be deemed complete at the time of deposit in the United States mail.

At the public hearing as scheduled, the City Council will hear all noticed or affected property owners who would be obligated to pay the abatement and related costs incurred by the City. The City Council shall confirm the appropriateness of persons to be held responsible for the noticed abatement charges and report to the City its final determinations of liability concerning the affected parties. Charges confirmed by the City Council and not paid within five (5) days of the public hearing date will be subject to lien and collection procedures and civil lawsuit as provided below.

The City shall record in the Office of the County Recorder of the County of Alameda, State of California, and a certificate substantially in the following form:

NOTICE OF SPECIAL ASSESSMENT LIEN

Pursuant to authority vested in me by the Fire Code of the City of Oakland, California, I did on the ____ day of ____, 20 ____, cause a condition to be abated or chargeable action to occur on the hereinafter-described real property at the expenses of the owner thereof, in the amount of \$____, and that said amount has not been paid nor any part thereof, and the City of Oakland does hereby claim a lien upon the hereinafter-described real property in said amount; the same shall be a lien upon the said real property until said sum, with interest thereon from the date of recordation of this lien in the Office of the County Recorder of the County of Alameda, State of California, and such other charges as may be applied from the City of Oakland Master Fee Schedule, has been paid in full. The real property hereinabove mentioned and upon which a lien is claimed is that certain parcel of land lying and being in the City of Oakland, County of Alameda, State of California, and particularly described as follows:

Assessor's Parcel Number:

Dated this _____ day of _____, 20 _____.

City Administrator or Designee

City of Oakland

A notary Public or other officer completing this certificate verifies only the identity of the individual who signed the document to which this certificate is attached, and not the truthfulness, accuracy, or validity of that document.

A notary Public or other officer completing this certificate verifies only the identity of the individual who signed the document to which this certificate is attached, and not the truthfulness, accuracy, or validity of that document.

The same shall be a lien against the property described therein until the amount thereof, plus accrued interest, has been paid in full. The amount of such lien shall draw interest thereon at a rate as established in the City of Oakland Master Fee Schedule from and after the date of the recording of said notice of the contents thereof.

Add: 115.3 Method of collection: additional amount of costs to tax bill procedure With the confirmation of the report by the City Council, the nuisance abatement charges contained therein that remain unpaid by the owner of the subject property shall constitute a special assessment against said property as it has received the special benefit of City abatement services. Such charges shall be collected, along with City administrative and reinspection fees at such time as is established by the Office of the County Assessor, County of Alameda, State of California for inclusion on the next property tax roll.

The City shall turnover to the Office of the County Assessor, County of Alameda, State of California for inclusion in the next property tax assessment the total sum of unpaid nuisance abatement charges consisting of the abatement costs, administrative and reinspection fees, fines, penalties, interest, and collection fees from the date of recordation of the lien, at the rate established and as described in the master fee schedule.

Thereafter, said assessment may be collected at the same time and in the same manner as ordinary municipal taxes are collected and shall be subject to the same penalties and the same procedure of sale as provided for ordinary delinquent municipal taxes. The special assessment shall be on parity and the same priority as general property taxes.

Add: 115.4 Judgment liens. A copy of every judgment imposing a fine or cost or both upon any owner of any real property for a violation of this Code thereon shall, upon the entry of judgment, be filed forthwith by

the City in the Office of the Recorder of Alameda County. The County Recorder shall index it immediately upon receiving it in the index of mechanics' liens. The fine, charges or administrative costs shall be a lien upon the real property from the time the certified copy of the judgment is filed in the Office of the Recorder, subject only to taxes, assessments, and water charges, and to mortgage and mechanics' liens existing on the real property prior to the filing.

Section 116. Oakland Municipal Code, Article 15, Chapter 15.64 Bedroom Window Security Bars and Smoke Detector Permit Requirements — *Add Section 116 as follows:*

Add: Section 116.1 Administration and Enforcement of Oakland Municipal Code, Title 15, Chapter 15.64 Bedroom Window Security Bars and Smoke Detector Permit Requirements. The City Administrator delegates to the Fire Code Official of the Fire Department the authority to enforce and administer the provisions of Oakland Municipal Code, Title 15, Chapter 15.64, entitled "Bedroom Window Security Bars and Grills." All City employees designated by the Fire Code Official are authorized to make necessary inspections and take any actions on behalf of the Fire Code Official as may be required to enforce and administer the provisions of Title 15 of the Oakland Municipal Code.

Title 15 of the Oakland Municipal Code will be administered and enforced in accordance with the powers vested in the Fire Code Official by applicable law, including but not limited to the 2022 California Fire Code and the provisions of Oakland Municipal Code.

Add: 116.2. Fire Hazard. Any residential or non-residential building or structure or property, portion thereof, device, apparatus, equipment, combustible waste or vegetation which, in the opinion of the Fire Code Official, is in such a condition as to cause a fire or explosion or provide a ready fuel to augment the spread and intensity of fire or explosion arising from any cause shall be considered Substandard and a Public Nuisance.

Add: 116.3 Faulty Materials of Construction. The use of materials of construction, except those which are specifically allowed or approved by this Code and the Oakland Building Code, and which have not been adequately maintained in good and safe condition, shall cause a residential or non-residential building or structure to be Substandard and a Public Nuisance.

Add: 116.4 Inadequate Exits. Except for those buildings or structures or portions thereof which have been provided with adequate exit facilities conforming to the provisions of this Code, residential and non-residential buildings or structures or portions thereof whose existing facilities were installed in violation of code requirements in effect at the time of their construction or whose exit facilities have not been increased in number or width in relation to any increase in occupant load due to alterations, additions or change in use or occupancy subsequent to the time of construction shall be considered Substandard and a Public Nuisance.

Notwithstanding compliance with code requirements in effect at the time of their construction, residential and non-residential buildings or structures or portions thereof shall be considered Substandard and a Public Nuisance when the Fire Code Official or the Building Official finds that an unsafe condition exists through an improper location of or length of travel to required exits, or a lack of an adequate number of width of required exits, or when other conditions exist which are dangerous to human life including, but not limited to, lack of or unapproved or improperly installed or improperly maintained illumination of required exits, directional signage to required exits, door and window release and security devices, and other obstructions to or within the exiting path of travel or emergency escape.

Add: 116.5 Inadequate Fire Protection or Firefighting Equipment. Residential and non-residential buildings or structures or portions thereof shall be considered Substandard and a Public Nuisance when they are not provided with the fire-resistive construction or fire-extinguishing systems or equipment required by this Code, except those buildings or structures or portions thereof which conformed with all applicable laws at the time of their construction and whose fire-resistive integrity and fire-extinguishing systems or equipment have been adequately maintained and improved in relation to any increase in occupant load, alteration or addition, or any change in occupancy.

Section 117. Declaration of Public Nuisance - Substandard — *Add Section 117 as follows:*

Add: 117 Any violations of the Oakland Fire Code deemed to be substandard and a public nuisance by the Fire Code Official or Building Official shall be subject to the enforcement and other proceedings set forth in the Oakland Building Code, Oakland Municipal Code Chapter 15.08 and 2022 California Fire Code.

CHAPTER 2 - DEFINITIONS

Section 202. General Definitions — *Amend Section 202 as follows:*

Add: ABANDONED shall mean tanks out of service and not being monitored in accordance with this Article and the provisions of the California Health and Safety Code shall be considered abandoned.

Add: CALIFORNIA FIRE CODE shall mean the International Building Code as amended and adopted by the State of California and is another name for the body of regulations known as the California Code of Regulations (C.C.R.), Title 24, Part 9; a portion of the "California Building Standards Code," as defined in the "California Building Standards Law" commencing with Section 18901 of the Health and Safety Code.

Add: CALIFORNIA ELECTRIC CODE shall mean the National Electric Code as amended and adopted by the State of California and is another name for the body of regulations known as the California Code of Regulations (C.C.R.), Title 24, Part 3; a portion of the "California Building Standards Code," as defined in the "California Building Standards Law" commencing with Section 18901 of the Health and Safety Code.

Add: CALIFORNIA MECHANICAL CODE shall mean the International Mechanical Code as amended and adopted by the State of California and is another name for the body of regulations known as the California Code of Regulations (C.C.R.), Title 24, Part 4; a portion of the "California Building Standards Code," as defined in the "California Building Standards Law" commencing with Section 18901 of the Health and Safety Code.

Add: CALIFORNIA PLUMBING CODE shall mean the International Plumbing Code as amended and adopted by the State of California and is another name for the body of regulations known as the California Code of Regulations (C.C.R.), Title 24, Part 5; a portion of the "California Building Standards Code," as defined in the "California Building Standards Law" commencing with Section 18901 of the Health and Safety Code.

Add: COMBINATION PERMIT allows the performance of building electrical, plumbing, and mechanical work under a single permit and may be issued for certain types of work which the Building Official has identified as being appropriate for such consideration. Fees shall be assessed as established in the Master Fee Schedule.

Add: COMBUSTIBLE MATERIAL is any material that, in the form in which it is used, stored, disposed and under the conditions anticipated, will ignite and burn or will add appreciable heat to an ambient fire.

Add: CONTINUOUS GAS DETECTION SYSTEM is an approved gas detection system where the analytical instrument is maintained in continuous operation and sampling is performed without interruption. Analysis is allowed to be performed on a cyclical basis at intervals not to exceed 5 minutes.

Add: CORROSIVE LIQUID is a liquid which, when in contact with living tissue, will cause destruction or irreversible alteration of such tissue by chemical action. Examples include acidic, alkaline or caustic materials. Such material will be considered prima facie corrosive when the pH is 2 or less or 12.5 or more, except for foodstuffs or medicine. This includes materials classified by DOT and Title 22 as corrosives.

Add: CURRENT CODE shall mean the edition of the California Building Code published by the International Code Council as adopted by the City of Oakland under California Health and Safety Code Section 18941.5. The edition to be applied shall be that edition in effect at the time damage occurs.

Add: DEPARTMENT HAVING JURISDICTION wherever reference is made in this Code to "Department Having Jurisdiction," it shall mean the Oakland Fire Department, and its successor in Title.

Add: ENGINEERING EVALUATION means an evaluation of a suspected damaged building or structure, performed under the direction of a fire protection engineer, structural engineer, civil engineer or architect retained by the owner of the building or structure. Engineering evaluations shall, at a minimum, contain recommendations for repair with an appropriate estimate of the construction cost for those repairs.

Add: ESSENTIAL SERVICE FACILITY shall mean that building or structure which has been designated by the City Council to house facilities that are necessary for emergency operations.

Amend: FALSE ALARM is the willful and knowing initiation or transmission of a signal, message or other notification of an event of fire when no such danger exists, or the activation of any fire alarm system due to malfunction, mechanical or electrical defect, improper operation or procedure by any person, or a false oral or written report to any department of the City of Oakland that an emergency exists requiring immediate or emergency response by the Oakland Fire Department

Amend: HIGHLY TOXIC.

Add: 4. A chemical that has a health hazard ranking of 4 in accordance with NFPA Standard 704.

Add: INDEX SHEET is a sheet located within the 1st or 2nd sheet of the plan set that lists all drawings and sheet numbers and a description of each drawing that is part of the plan set or other submittal document.

Amend: JURISDICTION means the City of Oakland.

Add: LOCAL FIRE ALARM shall mean a fire alarm system provided for notification and evacuation of occupants. It shall have more than one notification appliance on each and every floor. The system may notify a monitoring company at the discretion of the Fire Code Official.

Add: NON-PROFESSIONAL is a person that is not licensed or certified by the State of California but is not prohibited by state law from providing a certain service to others or performing certain work for oneself.

Add: OAKLAND BUILDING CONSTRUCTION CODE shall mean the compiled editions of the California Building Standards Codes, California Code of Regulations (CCR), Title 24, Part 2 (Building), Part 3 (Electrical), Part 4 (Mechanical), and Part 5 (Plumbing), and the Uniform Swimming Pool Spa and Hot Tub Code, with local amendments thereto as adopted by the Council of the City of Oakland.

Add: READILY ACCESSIBLE has the same definition as it is defined in the California Plumbing and Mechanical Codes.

Add: REMOVAL means the removal of tanks abandoned or permanently out of service from the ground which may require removal of all levels of containment, foundations, structures, or similar items which would obstruct soil sampling or cleanup of contaminated soil.

Add: REPLACEMENT VALUE is the dollar value, as determined by the building official based upon the square footage and the guidelines used in establishing the valuation of new construction, of replacing the damaged structure with a new structure of the same size, construction material and occupancy on the same site.

Add: SEALED (STAMPED) means the plan(s) is/are sealed, as required by California Business & Professions Code Sections 5536.1 and 5536.2, with originally applied ink applied to the print or copy of the plans or other submittal documents submitted with an application for permit. Information provided on the seal (stamp) shall be in accordance with California Business & Professions Code Section 5536.1 and Title 16, Section 136 of the California Code of Regulations.

Amend: SECONDARY CONTAINMENT is that level of containment that is external to and separate from primary containment and is capable of safely and securely containing the material, without discharge, for a period of time reasonably necessary to ensure detection and remedy of the primary containment failure.

Add: SEGREGATED is storage in the same room or area, but physically separated by distance and independent secondary containment from incompatible materials.

Add: SEMICONDUCTOR FABRICATION FACILITY OR COMPARABLE MANUFACTURING, RESEARCH AND DEVELOPMENT AREAS is a building or portion of a building classified as a Group H Occupancy in which electrical circuits or similarly manufactured devices are created.

Add: SIGNED shall mean the copies of a plan(s) that were previously "wet" signed (and sealed), and the image of such signing is apparent on the copies of the originals submitted with an application for permit. Also refer to the definition of "wet" signed.

Add: SPECULATIVE WAREHOUSING is a building constructed without a specific use, occupancy hazard designation, or tenant. Buildings that do not have a designed fire sprinkler system for a specific use (occupancy) or storage commodity classification.

Add: STORAGE OR USE FACILITY is a building, portion of a building, or exterior area used for the storage, use, or handling of hazardous materials where the quantity of hazardous materials is equal to or greater than the permit amounts specified in Appendix Chapter 1, Section 105.

Add: STORAGE OR USE SYSTEM is any one or combination of tanks, sumps, waste treatment facilities, pipes, vaults or other portable or fixed containers, and their secondary containment systems which are used, or designed to be used, for the storage, use, or handling of hazardous materials at a storage or use facility. For purposes of this code, a workstation having limited quantities of hazardous materials shall not be treated as a storage system.

Add: TEMPORARY INSTALLATIONS shall mean those that do not exceed one year.

Amend: TOXIC shall mean a chemical that has a health hazard rating of 3 in accordance with NFPA Standard 704.

Add: VALUE OF REPAIR is the dollar value, as determined by the building official, of making the necessary repairs to a damaged structure.

Add: VOLATILE SOLVENT means volatile organic compounds, including: (1) explosive gases, such as Butane, Propane, Xylene, Styrene, Gasoline, Kerosene, O₂ or H₂; and (2) dangerous poisons, toxins, or carcinogens, such as Methanol, Iso-propyl Alcohol, Methylene Chloride, Acetone, Benzene, Toluene, and Tri-chlor-ethylene.

Add: WASTE OIL is a Class III-B waste liquid resulting from the use of Class III-B combustible liquids such as waste motor oil, hydraulic oil, lubricating oil, brake fluids and transmission fluids.

Add: "WET" SIGNED shall mean the original plan(s) signed (and sealed) with originally applied ink to the plan(s) or other submittal documents submitted with an application for permit. Also refer to the definition of "signed."

Add: WILDLAND - URBAN INTERFACE FIRE AREAS is all of that area within the City as defined by the Fire Code Official of the City of Oakland, including, but not limited to, the area north and east of the following boundaries:

BEGINNING at the MacArthur Freeway at the San Leandro border to Foothill Boulevard; west on Foothill Boulevard to Stanley; west on Stanley to 98th Avenue; south on 98th Avenue to Stearns Avenue; west on Stearns to Burr Street; west on Burr Street to Thermal; west on Thermal to 8500 Thermal; south at 8500 Thermal to MacArthur Boulevard; west on MacArthur Boulevard to 82nd Avenue; north on 82nd Avenue to Utah Street; west on Utah Street to Partridge Avenue; south on Partridge Avenue to Outlook Avenue; west on Outlook Avenue to Seminary Avenue; south on Seminary Avenue to MacArthur Boulevard; west on MacArthur Boulevard to Buell Street; north on Buell Street to Tompkins Avenue; west on Tompkins Avenue to End; straight line from Tompkins Avenue to Wisconsin Street; west on Wisconsin Street to Carlsen Street; west on Carlsen Street to Maple Avenue; south on Maple Avenue to Morgan Avenue; west on Morgan Avenue to Barner; south on Barner to Morgan Avenue; west on Morgan Avenue to Coolidge Avenue; North on Coolidge Avenue to Alida Street; west on Alida Street to Lincoln Avenue; south on Lincoln Avenue to Tiffin Road; west on Tiffin Road to Whittle Avenue; west on Whittle Avenue to Fruitvale Avenue (Dimond Park); follow the southern and western boundary of Dimond Park to El Centro Road; west on El Centro Road to Dolores; west on Dolores to Park Boulevard; north on Park Boulevard to Piedmont boundary; Piedmont boundary to Mt. View Cemetery; northern boundary of Mt. View Cemetery to Clarewood Drive; west on Clarewood Drive to Broadway Terrace; south on Broadway Terrace to Margarido Drive; west on Margarido Drive to Lawton; west on Lawton to Broadway; north on Broadway to Keith Avenue; west on Keith Avenue to College Avenue; and north on College Avenue to the corporate limits of the City of Berkeley.

Amend: WORKSTATION is a defined space or independent principal piece of equipment using hazardous materials where a specific function, laboratory procedure or research activity occurs. Approved or listed

hazardous materials storage cabinets, flammable liquid storage cabinets or gas cabinets serving a workstation are included as part of the workstation. A workstation is allowed to contain ventilation equipment, fire protection devices, electrical devices, and other processing and scientific equipment.

CHAPTER 3 - GENERAL REQUIREMENTS

Section 307. Open Burning, Recreational Fires and Portable Outdoor Fireplaces - *Amend Section 307 as follows:*

Amend: 307.4.3 Portable outdoor fireplaces. Portable outdoor fireplaces shall be used in accordance with the manufacturer's instructions and shall not be operated within 15 feet (3048 mm) of a structure or combustible material.

Exceptions:

1. Portable outdoor fireplaces used at one and two-family dwellings located outside of a wildland-urban interface fire area, when used in accordance with the manufacturer's instructions.
2. Portable outdoor fireplaces used at one- and two-family dwellings located within a wildland-urban interface fire area shall be located at least 15 feet (4572 mm) from a structure, combustible material or vegetation. Such outdoor fireplaces shall be used in accordance with the manufacturer's instructions.

Add: 307.4.4 "Red-flag" and other high fire risk conditions. Open burning, including recreational fires and fires within portable outdoor fireplaces, shall not be permitted on "red-flag" or other days which pose a high fire risk as determined by the Fire Code Official.

Section 308. Open Flames – *Amend Section 308 as follows:*

Amend: 308.1.5 Location near combustibles. Open flames such as from candles, lanterns, kerosene heaters and, gas-fired heaters, barbecues, fire-pits and similar devices shall not be located, on or near decorative material or, on or near similar combustible materials or within 10 feet (3048 mm) of combustible construction.

Exceptions:

1. Open-flame cooking devices complying with section 308.1.4 of this code shall be permitted provided a minimum separation of 10 feet (3048 mm) from vegetation is maintained.
2. Approved open-flame heating devices shall be permitted for one- and two-family dwellings provided a minimum separation of 10 feet (3048 mm) from vegetation is maintained.

CHAPTER 5 - FIRE SERVICE FEATURES

Section 503. Fire Apparatus Access Roads - *Amend Section 503 as follows:*

Add: 503.1.4 Access to Open Spaces. When existing access to open land or space, or to fire trail systems maintained for public or private use, is obstructed by new development of any kind, the developer shall provide an alternate means of access into the area that is sufficient to allow access for fire personnel and apparatus. The alternate means of access must be approved by the Fire Code official.

Amend: 503.2.1 Dimensions. Fire apparatus access roads shall meet the requirements outlined in Figures 1 and 3A and for approved security gates in accordance with Section 503.6, and an unobstructed vertical clearance of 13 feet 6 inches (4,115 mm).

Amend: 503.3 Marking, Fire Lanes. Where necessary to maintain adequate emergency vehicle access to buildings or fire apparatus access roads, the Fire Code Official may establish designated "Fire Lanes." Designated Fire Lanes shall comply with section 503.2.1 and 503.2.2 with markings or signs containing the words "NO PARKING-FIRE LANE."

The means by which fire lanes are designated shall be maintained in a clean and legible condition at all times and be replaced when necessary to provide adequate visibility.

Amend: 503.4 Obstruction of fire apparatus access roads. Fire apparatus access roads shall not be obstructed in any manner, which includes parking of vehicles. The minimum width and clearances established by Sections 503.2.1 and 503.2.2, or as applicable, Appendix Section D105, shall be maintained at all times.

Add: 503.6.1 Automatic security gates, infrared receiver. Where permitted, an automatic security gates that crosses fire department access roadways, shall be equipped with an approved infrared receiver and key override switch approved by the Fire Code Official.

Add: 503.6.2 Manual security gates, key box. Manual security gates shall be equipped with an approved key box.

Section 504 - Access to Building Openings and Roofs — Amend Section 504 as follows:

Add: 504.5 Access Control Devices. When access control devices including bars, grates, gates, electric or magnetic locks or similar devices, which would inhibit rapid fire department emergency access to the Fire Department, are installed, such devices shall be approved by the Fire Code Official. All access control devices shall be provided with an approved means for deactivation or unlocking by the fire department. Access control devices shall also comply with Chapter 10 Egress.

Add: 504.6 Roof Guardrails at Interior Courts. Roof openings into interior courts that are bounded on all sides by fire resistive construction shall be protected with guardrails. The top of the guardrail shall not be less than 42 inches in height above the adjacent roof surface that can be walked on. Intermediate rails shall be designed and spaced such that a 4-inch diameter sphere cannot pass through.

Exception: Where the roof opening is greater than 600 square feet in area.

Add: 504.7 Door signage. When required by the Fire Code Official, interior and exterior doors shall be provided with permanent signs to facilitate fire department emergency access. Signage shall be approved by the Fire Code Official.

Section 506 - Key Boxes - Amend Section 506 as follows:

Add: 506.3 Emergency information boxes. When an occupancy contains storage of hazardous materials that exceed the exempt amounts listed in Chapter 50 of the California Fire Code, or the occupancy is required by the Fire Code Official to have available on site pre-fire plans, the Fire Code Official may require an approved emergency information box be installed on the premises for the storage of such information. The emergency information box shall be installed in an approved location and the enclosed information shall be updated, annually or as changes dictate, by the occupant.

Section 507 - Fire Protection Water Supplies - Amend Section 507 is as follows:

Amend: 507.5.1 Distribution of fire hydrants. Fire hydrants shall be nominally spaced every 500 linear feet in residential areas comprised of single-family dwellings. In commercial or industrial areas, or in residential areas containing condominiums, townhouses, or apartments, fire hydrants shall be nominally spaced every 300 feet. The Fire Code Official may require that fire hydrants be placed at closer intervals to conform to street intersections, unusual street curvatures, or fire-flow requirements. Divided streets shall have hydrants on both sides of the street and shall, where applicable, be installed in alternate or staggered positions so that hydrants will not be directly across from each other.

Exceptions: Delete

Add: 507.5.7 Hydrants. The Fire Code Official is authorized to determine the types of hydrants acceptable for installation. In areas where public or private water mains are not available for the provision of required fire flow, the Fire Code Official may require that water supply for firefighting is provided in accordance with the most current addition of NFPA Standard #1142, (Standard on Water Supplies for Suburban and Rural Fire Fighting).

Add: 507.5.8 Hydrant Identification. All fire hydrants shall be identified with a reflective, raised, blue pavement marker installed in the centerline of public and private roadways perpendicular to the location of the hydrant. Fire hydrants shall also be painted in accordance with the standard detail issued by the City of Oakland. Public and private hydrant shall be periodically painted to maintain rust protection and visibility.

Sections 508 - Fire Command Center - Amend Section 508 as follows:

Amend: 508.1 General. Where required by other sections of this code and in all buildings four (4) or more stories in height or having 45,000 square feet or more total building area and all buildings classified as high-rise buildings by the California Building Code and Group I-2 occupancies having occupied floors located more than 75 feet above the lowest level of fire department vehicle access, a fire command center for fire department operations shall be provided and shall comply with Sections 508.1.1 through 508.1.9.

Add: 508.1.3.1 Size for Buildings Other than high-rise buildings. In buildings four (4) or more stories in height with 45,000 square feet or more total building area but not classified as a "high-rise" by the California Building Code, the fire command center shall be a minimum of 96 square feet (9 m²) with a minimum dimension of 8 feet (2438mm).

Add: 508.1.9 Building Evacuation Floor Map Signs. Buildings two (2) or more stories in height and all buildings classified as high-rise buildings by the California Building Code shall post a floor plan sign which provide emergency procedures at every exit access stairway, elevator landing, and immediately inside all public entrances to the building. Information contained in the floor plan signs shall include, but not be limited to the following:

1. Location of exits and fire alarm initiating stations;
2. Description of fire alarm sounds and appearance;
3. Fire Department emergency telephone number 911;
4. Prohibition of the use of elevators during emergencies;
5. Instructions to be followed by ambulatory, non-ambulatory, and disabled persons in the event of an emergency
6. Notation "you are here" or other readily understandable marking specifying the location on the floor plan sign.
7. Floor plan signs shall be printed in non-decorative lettering which shall not be less than three-sixteenths of an inch (3/16") in height and shall provide a sharp contrast with the background. The information shall accurately depict the layout of the floor where the sign is located.

Section 510 Emergency Responder Communication Coverage - Amend Section 510.1 as follows:

Amend: 510.1

Exception 2 Where the fire code official has determined that the 800 MHz and 700 MHz frequencies for the radio coverage system within the building are not needed.

CHAPTER 6 - BUILDING SERVICES AND SYSTEMS

Section 603 Electrical Equipment, Wiring, and Hazards - Amend Section 603 as follows:

Add: 603.1.3 Immersion Heaters. All electrical immersion heaters used in dip tanks, sinks, vats and similar operations shall be provided with approved over-temperature controls and low liquid level electrical disconnects. Manual reset of required protection devices shall be provided.

Section 605 Fuel Fire Appliances - Amend Section 605 as follows:

Amend: 605.5 Portable Unvented Heaters. Portable unvented fuel fired heating equipment shall be prohibited in occupancies in Groups A, E, I, R-1, R-2, R-2.1, R-3, R-3.1 and R-4 and ambulatory care facilities. Use of portable unvented heaters at any outside location shall be approved by the Fire Code Official.

CHAPTER 9 - FIRE PROTECTION SYSTEMS

Section 903 Automatic Sprinkler Systems - Amend Section 903 as follows:

Amend: 903.2 Where required. Approved automatic sprinkler systems in new buildings and structures shall be provided in the locations described in this Section.

Exceptions:

- (a). Automatic fire sprinkler protection for fixed guideway transit systems shall be as per Section 903.2.17.
- (b). Canopies over motor vehicle fuel dispensing facilities when constructed in accordance with Section 406.7.2 of the 2022 California Building Code.
- (c). Temporary construction trailers, less than 1,650 sq ft, on-site less than one year and 20' from property lines, building, structures and combustibles.
- (d). The following detached Group U occupancies: Barns, fences more than 6 feet high, grain silos accessory to residential occupancies, green houses, gazebos or similar structures accessory to residential occupancies, livestock shelters, retaining walls, tool or storage sheds, stables, tanks, towers
- (e). Detached Group U occupancies housing dumpsters or refuse containers with floor areas of 500 sq. ft. or less are exempt from installation of automatic fire extinguishing systems.
- (f). Detached one-story Group U occupancies housing dumpsters or refuse containers with floor area up to 1500 sq ft are exempt from installation of automatic fire extinguishing systems provided all of the following requirements are met:
 - a. Building is constructed to Type IV, Type V 1-Hour, or a higher fire-resistive construction, and
 - b. Minimum five-foot setback to property line and ten-foot setback to any other building on the site is maintained.
- (g). Airport Control Towers (see 903.2.11.3 exception #1)

- (h). Parking shade structures or solar trellises when constructed of non-combustible materials, set back from property lines and separated from buildings in accordance with the California Building Code.

Amend: 903.2.1 Group A and B. An automatic sprinkler system shall be provided throughout buildings and portions thereof used as Group A and B occupancies.

Amend: 903.2.1.1 Group A-1. An automatic sprinkler system shall be provided throughout Group A-1 occupancies.

Amend: 903.2.1.2 Group A-2. An automatic sprinkler system shall be provided throughout Group A-2 occupancies.

Amend: 903.2.1.3 Group A-3. An automatic sprinkler system shall be provided throughout Group A-3 occupancies.

Amend: 903.2.1.4 Group A-4. An automatic sprinkler system shall be provided throughout Group A-4 occupancies.

Amend: 903.2.1.5 Group A-5. An automatic sprinkler system shall be provided throughout Group A-5 occupancies.

Amend: 903.2.1.6. Assembly occupancies on roofs. Where an occupied roof has an assembly occupancy, all floors between the occupied roof and the level of exit discharge shall be equipped with an automatic sprinkler system in accordance with section 903.3.1.1 or 903.3.1.2.

Exception: Deleted.

Amend: 903.2.2 Ambulatory care facilities. An automatic sprinkler system shall be provided throughout Ambulatory care facilities.

Amend: 903.2.3 Group E. Except as provided for in Sections 903.2.20 for a new public school campus and 907.2.29 (fire alarm and detection) for modernization of an existing public school campus building(s), an automatic sprinkler system shall be provided for Group E occupancies.

Amend: 903.2.4 Group F. An automatic sprinkler system shall be provided throughout all buildings containing Group F occupancies.

Amend: 903.2.5 Group H. An automatic sprinkler system shall be provided throughout all buildings containing Group H occupancies.

Amend: 903.2.5.31 Pyroxylin plastics. An automatic sprinkler system shall be provided throughout all buildings, portions thereof, where cellulose nitrate film or pyroxylin plastics are manufactured, stored or handled in quantities exceeding 100 pounds (45kg).

Amend: 903.2.6 Group I. An automatic sprinkler system shall be provided throughout buildings with a Group I fire area.

Amend: 903.2.7 Group M. An automatic sprinkler system shall be provided throughout buildings containing a Group M occupancy.

Amend: 903.2.8 Group R. An automatic sprinkler system installed in accordance with Section 903.3 shall be provided throughout all buildings with a Group R fire area.

Amend: 903.2.9 Group S-1. An automatic sprinkler system shall be provided throughout all buildings containing a Group S-1 occupancy.

Amend: 903.2.10 Group S-2. An automatic sprinkler system shall be provided throughout buildings classified as parking garages in accordance with Section 406.4 of the California Building Code or where located beneath other groups.

Amend: 903.2.10.1 Commercial Parking Garages. An automatic sprinkler system shall be provided throughout buildings used for the storage of commercial trucks, buses, and cars.

Amend: 903.2.11 Specific building areas and hazards. In all occupancies, an automatic sprinkler system shall be installed for building design or hazards in the locations set forth in Sections 903.2.11.1 through 903.2.11.6.

Amend: 903.2.11.1 Stories without openings. An automatic sprinkler system shall be installed throughout every story or basement without openings.

Amend: 903.2.18 Group U private garages and carports accessory to Group R-3 occupancies. Carports and attached garages, accessory to Group R-3 occupancies, shall be protected by residential fire sprinklers in accordance with this Section. Residential fire sprinklers shall be connected to, and installed in accordance with, an automatic residential fire sprinkler system that complies with section R313 of the California Residential Code or with NFPA 13-D. Fire sprinklers shall be residential or quick response sprinklers, designed to provide a minimum density of .05 gpm/ft² over the area of the garage and/or carport, but not to exceed two sprinklers for hydraulic calculation purposes. Garage doors shall not be considered obstructions with respect to sprinkler placement.

Deleted: Exception

Add: 903.2.22 Additions to Group A, B, E, F, H, I, L, M, R, S, and certain miscellaneous group U occupancies. For additions to existing Group A, B, E, F, H, I, L, M, R, S, and U occupancies not exempted in 903.2, an automatic fire extinguishing system (AFES) shall be required throughout the entire building when one of the following thresholds is exceeded. For purposes of floor area calculations, Group U (private garages or similar) occupancies shall be included in the floor area calculation.

1. The combined floor area of the existing building plus the addition exceeds 3,600 square feet, or
2. The addition exceeds 500 square feet, or
3. The addition increases the floor area of the existing building by 50%. The increase in floor area shall be calculated cumulatively from July 1, 1999.

Exception: The existing portion of a one or two story building with no basement does not require automatic fire extinguishing systems when all the following conditions are met:

- (a) The addition is protected by an AFES.
- (b) The addition and the existing structure are separated with fire walls, have required protection, and fire rated openings and construction is in accordance with the California Building Code based on Type of Occupancy and Construction type.
- (c) Assembly, Education, Institutional and Multi-Family Residential occupancies install an underwriter laboratory certified and National Fire Protection Association Standard 72 compliant fire alarm system.

Add: 903.2.23 Additions to existing R-3 occupancies. For additions to R-3 occupancies, an automatic fire sprinkling system shall be required throughout the entire building when one of the following thresholds

is exceeded. For purposes of floor area calculations, Group U (private garages or similar) occupancies shall be included in the floor area calculation:

1. The combined floor area of the existing building plus the addition exceeds 3,600 square feet, or
2. The addition exceeds 500 square feet; or
3. The addition increases the floor area of the existing structure by 50%.

Consistent with the State Fire Marshal Information Bulletin 17-001, also referenced in State Fire Marshal Guideline Bulletin 21-005, the **Department Having Jurisdiction** requires an automatic residential sprinkler system when the square footage exceeds the prescribed amounts listed above in this section. Also consistent with State Fire Marshal Information Bulletin 17-001, new detached accessory dwelling units are required to comply with the standards for fire protection such as water supply and/or fire department access. Automatic residential sprinkler systems provide construction options for the owner by providing different ways of complying with the fire protection requirements.

Exception: The entire residence including the addition does not require an AFES when the following conditions are met:

- (a) The approved addition is greater than 500 square feet and the cumulative floor area is 3,600 square feet or less and an approved local, hard wired or similarly configured, alarm system are installed throughout the existing structure and the addition.
- (b) No Planning or Building Department variances or exceptions are needed to accommodate the addition.
- (c) Exception (a) may be used only once for the first addition or conversion of existing space to habitable space occurring after January 1, 2008.
- (d) The addition or modification meets the city requirements for detached secondary/accessory dwelling units, or
- (e) The addition or modification meets the city requirements for attached secondary/accessory dwelling units

Add: 903.2.24 Repair/Retrofit. All occupancies except Group U occupancies exempted in 903.2 damaged during a fire or natural disaster shall require an automatic fire-extinguishing system to be installed in the entire structure. Retrofit criteria shall be as follows:

1. All installations of automatic fire extinguishing systems and signaling devices shall comply with the then current code.
2. Any occupancy that has been damaged as a result of a fire or natural disaster, except as otherwise noted, shall be retrofitted with an automatic fire extinguishing system to the entire building and structure in accordance with the following criteria:
 - a. When the estimated value of repair is less than 50 percent (50%) of the replacement value of the structure, the damaged portion(s) may be restored to their pre-damaged condition.
 - b. When the estimated value of repair is 50 percent (50%) or more of the replacement value of the structure, the entire building shall be retrofitted with an automatic fire extinguishing system.

Add: 903.2.25 Retrofit for Essential Services Facilities. When the estimated value of repair contained in the engineering evaluation is more than thirty percent (30%) of the replacement value of the structure, the entire building shall be retrofitted with an automatic fire extinguishing system.

Add: 903.2.26 Retrofit for Historic Buildings or Structures. The minimum criteria for retrofit of Historic Buildings or Structures shall be in accordance with the California Code of Regulations and the State of California Historic Building Code, shall apply.

Where conflicts exist between the standards contained herein and the State of California Historic Building Code, the Historic Building Code shall govern.

Amend: 903.3.1.2 NFPA 13R in Group R Occupancies. Automatic sprinkler system in group R occupancies up to and including 4 stories in height shall be permitted to be installed throughout in accordance with NFPA 13R as amended in Chapter 80 and as follows.

The sprinkler system shall include protection in the following areas: garages, carports, bathrooms, concealed spaces, closets, water heater closets, laundry rooms, attic spaces, under walkways, or overhangs, balconies or decks greater than four feet in depth, at each floor under stair landing that is wholly or partially enclosed, and other areas where deemed necessary by the Fire Code Official and the Building Official to protect the public health and safety.

The number of stories of Group R occupancies constructed in accordance with Sections 510.2 and 510.4 of the California Building Code shall be measured from the horizontal assembly creating separate buildings.

Add: 903.3.1.3.1 NFPA 13D in Group R-3 Occupancies. An automatic fire sprinkler system shall be installed in all Group R-3 occupancies including garages, detached garages over 500 square feet, and other attached rooms.

When an Automatic Fire Extinguishing System is required, the system in R-3 occupancies up to 12,000 square feet shall be installed to a modified NFPA 13D standard as follows:

A modified NFPA 13D system shall include areas such as: garages, carports, bathrooms, concealed spaces, closets, water heater closets, laundry rooms and attic spaces, under walkways, overhangs or balconies over four feet in depth, at each floor under stair landing that is wholly or partially enclosed; and meet the following requirements:

1. A one-inch water meter or larger may be required to meet AFES hydraulic calculations.
2. For new residences over 5,000 square feet, hydraulic calculations shall be required for all sprinkler heads in the most remote fire area up to a maximum of four sprinkler heads. For new residences of less than 5,000 square feet, hydraulic calculations shall be required for all sprinkler heads in the most remote area up to a maximum of two sprinkler heads.
3. Fifteen gallons per minute for domestic use shall be added at the domestic and fire water supply split point.
4. In residences with high, sloped, beamed, soffited, cathedral ceilings or smooth flat ceilings greater than nine feet, additional fire sprinkler head discharge calculations may be required.
5. Dielectric fittings shall be provided when using copper with steel riser assemblies.
6. Each system shall have a single control valve arranged to shut off both the domestic and sprinkler systems.
7. In residential sprinkler projects, the Fire Code Official with the concurrence of the building official may grant alternate methods of construction.

Exceptions. This section does not apply to:

- (a) Any structure exempt from permit requirements per the currently adopted California Building Code or the California Fire Code is exempt from the requirements for fire sprinklers.
- (b) All exterior decks without roof covering adjacent to R-3 occupancies, unless otherwise required by the Fire Code Official or building official. This exemption shall not apply to R-3 occupancies in the Wildland Urban Interface Area.

Add: 903.3.5.3 Underground water supply. The location of the fire department connection, post indicator valve and the routing of the water supply for multi-building facilities shall be evaluated on an individual basis.

Amend: 903.3.7 Fire department connections. A fire department connection shall be provided for all buildings, or when the Fire Code Official deems them necessary. The location of fire department connections shall be approved by the Fire Code Official.

Amend: 903.3.9 Floor control valves. Floor control valves and water flow detection assemblies shall be installed at each floor. An exterior control valve shall be provided for all buildings.

Exception: Group R-2 without an interior hallway, R-3 and R-3.1.

Amend: 903.4.1 Monitoring. Alarm, supervisory and trouble signals shall be distinctly and descriptively different, transmitted to the control panel, local annunciator and automatically transmitted to an approved central station, remote supervising station, or proprietary supervising station as defined in NFPA 72. When approved by the Fire Code Official, signals may sound an audible signal at a constantly attended location.

Deleted: Exceptions

Amend: 903.4.2 Alarms. Approved audible devices shall be connected to every automatic sprinkler system. Such sprinkler water-flow alarms devices shall be activated by water flow equivalent to the flow of a single sprinkler of the smallest orifice size installed in the system. Alarm devices shall be provided inside each tenant space in a normally occupied area and on the exterior of the building in an approved location. Where a fire alarm system is installed, actuation of the automatic sprinkler system shall activate the building fire alarm system.

Group R-3 occupancies shall have local alarms. Local alarms shall be of sufficient intensity to be clearly audible in all bedrooms over background noise levels with all intervening doors closed.

1. An exterior alarm bell shall be installed on the front 1/3 of the building facing public or private street access.
2. Interior alarm devices (minimum DCBL rating of 88) may be recessed into the wall, centrally located between sleeping rooms in hallway.
3. Such alarms shall be audible in all sleeping rooms with doors closed.

Add: 903.4.4 Central Station Monitoring. An approved central alarm monitoring company shall mean approved by the State Fire Code Official or a nationally recognized testing laboratory. All alarm transmitting devices and systems shall be installed and maintained in accordance with nationally recognized standards.

Valve supervision, water-flow alarm and trouble signals shall be distinctly different and shall be automatically transmitted to an approved central station, remote station or proprietary supervising station as defined by national standards or, when approved by the building official with the concurrence of the Fire Code Official, sound an audible signal at a consistently attended location.

Exceptions:

- (a) Underground key or hub valves in roadway boxes provided by the municipality or public utility need not be supervised.
- (b) Monitored systems are not required for Group R-3 occupancies.

Add: 903.7 Underground corrosion protection. A corrosion protection plan, including details and specifications for all ferrous underground piping must be designed and provided by a qualified corrosion engineer.

Exception: underground piping systems with cathodic protection on all ferrous piping.

Add: 903.8 Control Valves. Control valves and flow switches shall be installed on each floor. All control valves shall be monitored by a Central Station.

Exceptions:

1. Control valves per floor not required on single family houses.
2. Existing buildings where T.I. work modifications to a sprinkler system covers less than 20 sprinkler heads need not upgrade to have separately monitored floors.
3. Vertically-separated individual R-2 dwelling units (townhomes) with individual water meters may have dual-service meters when approved by the water purveyor.

Add: 903.9 Stages. All stages shall be provided with an automatic fire extinguishing system. Such systems shall be provided throughout the stage and in dressing rooms, workshops, storerooms and other accessory spaces contiguous to such stages.

Add: 903.10 Stairs. An automatic sprinkler system shall be installed in enclosed usable space below or over a stairway in all occupancies.

Add: 903.11 Speculative Warehousing. The sprinkler system shall be designed to discharge at the following rates:

1. Where clear ceiling heights are 20 feet or less, 0.33 gallons per minute, per square foot, over a minimum area of 3,000 square feet.
2. Where clear ceiling heights are between 20 and 30 feet, 0.495 gallons per minute, per square foot, over a minimum area of 3,000 square feet.
3. Where clear ceiling heights are over 30 feet, 0.60 gallons per minute, per square foot, over a minimum of 3,000 square feet.

Add: 903.12 Modification to existing automatic fire extinguishing system (AFES). All changes or additions to any existing automatic fire sprinkler systems or underground fire lines must comply with all regulations within this Section.

Section 904 Alternative Automatic Fire-Extinguishing Systems — Amend Section 904 as follows:

Add: 904.12.6 Ventilating Hood and Duct Systems and Air Handlers. All buildings with an existing or new fire alarm/sprinkler monitoring control panel shall interconnect all hood and duct systems and air handlers equal or greater than 2000 cfm to the alarm panel. The hood and duct shall report to a central station as a fire condition. Air handlers shall report as a supervisory or trouble condition when the building is provided with fire sprinklers. They shall report as an alarm in buildings without fire sprinklers.

Section 905 Standpipes - Amend Section 905 as follows:

Add: 905.1.1 Hose connections. All Class I, II and III standpipe outlets in multi-storied buildings or buildings with basements shall be installed on intermediate landings between floors, unless otherwise approved by fire code official.

Amend: 905.3.2 Group A.

Exceptions: deleted

Section 907 Fire Alarm and Detection Systems - Amend Section 907 as follows:

Amend: 907.1.3 Equipment. Systems and their components shall be California State Fire Code Official listed and approved for the purpose for which they are installed. The building owner shall provide a serially numbered certificate from an approved nationally recognized testing laboratory for all fire alarm systems indicating that the system has been installed in accordance with the approved plans and specification and meets minimum NFPA Standards. A copy shall be provided to the Fire Code Official's office at no cost to the city. Certification shall be required for all new systems to be installed after January 1, 1996. Existing systems that can no longer be serviced or maintained or those that are deemed problematic shall also be required to obtain this certification within 12 months of notification.

Add: 907.1.3.1 Remote Annunciator Location. All new or existing systems that require a new Fire Alarm Control Panel shall have a remote annunciator at the main entrance. It shall be visible to approaching emergency personnel.

Amend: 907.2 Where required—new buildings and structures. An approved fire alarm system installed in accordance with the provisions of this code and NFPA 72 shall be provided in new buildings and structures in accordance with Sections 907.2. through 907.2.23 and provide occupant notification in accordance with Section 907.5, unless other requirements are provided by another section of this code.

A minimum of one manual fire alarm box shall be provided in an approved location to initiate a fire alarm signal for fire alarm systems employing automatic fire detectors or water-flow detection devices. Where

other sections of this code allow elimination of fire alarm boxes due to sprinklers or automatic fire alarm systems, a single fire alarm box shall be installed at a location approved by the enforcing agency.

Exceptions: Deleted

Add: 907.2.5.2 All new H occupancies, or existing H occupancies that require a new fire alarm control panel, and that have a local detection systems(s) shall interconnect, or otherwise configure, the system(s) to report to a Central Station as a fire condition or alarm condition. The report shall be in nomenclature easy to understand (e. g. Water, not H2O).

Amend: 907.2.9.1 Manual fire alarm system. Exception: (3) Deleted

Amend: 907.3 Fire safety functions. Automatic fire detectors utilized for the purpose of performing fire safety functions shall be connected to the building's fire alarm control unit where a fire alarm or sprinkler monitoring system is installed. Detectors shall, upon actuation, perform the intended function and activate the alarm notification appliance or activate a visible and audible supervisory signal at a constantly attended location when approved by the Fire Code Official. In buildings not required to be equipped with a fire alarm or sprinkler monitoring system, the automatic fire detector shall be powered by normal electrical service and, upon actuation, perform the intended function. The detectors shall be located in accordance with NFPA 72.

Amend: 907.3.1 Duct Smoke Detectors. Smoke detectors installed in ducts shall be listed for the air velocity, temperature and humidity present in the duct. Duct smoke detectors shall be connected to the building's fire alarm control unit when a fire alarm or sprinkler monitoring is installed. Activation of a duct smoke detector shall initiate a visible and audible supervisory signal at a central station or when approved by the Fire Code Official at a constantly attended location and shall perform the intended fire safety function in accordance with this code and the California Mechanical Code. Duct smoke detectors shall not be used as a substitute for required open area detection.

Exceptions:

1. The supervisory signal at a constantly attended location is not required where duct smoke detectors activate the building's notification appliances.
2. In occupancies, not required to be equipped with a fire alarm or sprinkler monitoring system, actuation of a smoke detector shall activate a visible and an audible signal in an approved location and shall be identified as air duct detector supervisory.

Add: 907.5.2.1.5 Audible Alarms. Approved audible devices shall be connected to every automatic sprinkler system. Such sprinkler water-flow alarms devices shall be activated by water flow equivalent to the flow of a single sprinkler of the smallest orifice size installed in the system. Audible alarm devices shall be provided inside each tenant space in a normally occupied area and on the exterior of the building in an approved location. Where a fire alarm system or sprinkler water flow monitoring is installed, actuation of the automatic sprinkler system shall activate the building fire alarm system.

Amend: 907.6.2 Power Supply. The primary and secondary power supply for the alarm system shall be provided in accordance with NFPA 72.

Exception: Deleted

Amend: 907.6.6 Monitoring. Fire alarm system shall transmit distinctly and descriptively different alarm, supervisory and trouble signals to an approved supervising station in accordance with NFPA 72 or when approved by the Fire Code Official, shall sound an audible signal at a constantly attended location.

Exceptions:

1. Single and multiple-station smoke alarms required by Section 907.2.10
2. Group I-3 occupancies shall be monitored in accordance with Section 907.2.6.3
3. Automatic sprinkler systems in one and two family dwellings.

Add: 908.3.1 Carbon dioxide (CO2) systems all other occupancies. Emergency alarm system shall comply with section 5307.3.2. Emergency alarm system shall be interconnected and monitored by building fire alarm system.

Section 914 Fire Protection Based on Special Detailed Requirements of Use and Occupancy - Amend Section 914 as follows:

Amend: 914.2.3 Emergency voice/alarm communication system. Covered malls buildings shall be provided with an emergency voice/alarm communication system. Emergency voice/alarm communication system serving a mall, required or otherwise shall be accessible to the fire department. The system shall be provided in accordance with Section 907.5.2.2.

CHAPTER 10 - MEANS OF EGRESS

Section 1033 Special Egress Graphics – Amend Section 1033 as follows:

Add: 1033.1 General. When required by the Fire Code Official, a special egress graphics package shall be incorporated into new and existing structures. Such structures may include parking structures, warehouses, high-rise buildings, mid-rise buildings, complex projects, or when required by the Fire Code Official. The package may include one or more of the following:

1. **Oversized exit identification.** Signs or graphics shall be provided to assist in identification of exits, and shall be so designed and installed so as to be visible to occupants from a distance of not less than 300 feet (91,440 mm).
2. **Supplemental egress graphics.** Supplemental egress graphics shall be provided to assist in the orderly and safe evacuation or relocation of people. Such graphics shall be performance based and include way-finding to identify egress paths and termination points.
3. **Means of egress - finishes.** Means of egress shall be painted and / or otherwise finished with building-standard finishes, or as otherwise approved by the Fire Code Official.

CHAPTER 11 - CONSTRUCTION REQUIREMENTS FOR EXISTING BUILDINGS

Section 1103 Fire Safety Requirements for Existing Buildings - Amend Section 1103 as follows:

Amend: 1103.2 Exception: Where the fire code official has determined that the 800 MHz and 700 MHz frequencies for radio coverage within the building are not needed.

Amend: 1103.7.6 Group R-2. An automatic and manual fire alarm system that activates the occupant notification system in accordance with Section 907.5 shall be installed in existing Group R-2 occupancies more than three stories in height or with more than 16 dwelling or sleeping units.

CHAPTER 12 - ENERGY SYSTEMS

SECTION 1204 PORTABLE GENERATORS- Amend Section 1204 as follows

Add: 1204.3.1 Standby power generators shall have a permit issued by the Fire Code official for a period of no longer than 180 days.

SECTION 1206 STATIONARY FUEL CELL POWER SYSTEMS- Add Section 1206 as follows

Add: 1206.7.1 Final approval of the Stationary Cell Power System must be provided by the Fire Code Official prior to installation of the protective barriers

Section 1207- Electrical Energy Storage Systems – Amend Section 1207 as follows:

Add: 1207.1.4.1.1 **Failure of Ventilation System.** Failure of the ventilation system shall automatically disengage the charging system.

Add: 1207.7.11.11 For ESS systems installed in the High Fire Severity Zone - see fire suppression requirements in chapter 49

CHAPTER 28 - LUMBERYARDS AND AGRO-INDUSTRIAL, SOLID BIOMASS AND WOODWORKING FACILITIES

Section 2807 Storage and Processing of Wood Chips and Hogged Material Associated with Timber and Lumber Production Facilities - Amend Section 2807 as follows:

Add: 2807.6 Fire Protection Water Supply Systems. An approved fire protection water supply and hydrant system suitable for the fire hazard involved shall be provided for open storage yards and processing areas. Hydrant systems shall be installed in accordance with NFPA 24.

CHAPTER 33 - FIRE SAFETY DURING CONSTRUCTION AND DEMOLITION

Section 3305 Precautions against Fire - Amend Section 3304 as follows:

Add: 3305.10 Fire Walls. When walls are required to be of fire resistive construction, the wall construction shall be completed (with all openings protected) immediately after the occupancy is sufficiently weather-protected at the location of the wall(s).

Section 3312 Means of Egress - Amend Section 3312 as follows:

Amend: 3312.1 Stairways Required. Each level above the first story in new multi-story buildings shall be provided with at least two usable exit stairways after the floor decking is installed. The stairways shall be continuous and discharge to grade level. Stairways serving more than two floor levels shall be enclosed (with openings adequately protected) after exterior walls/windows are in place. Exit stairs in new and in existing, occupied buildings shall be lighted and maintained clear of debris and construction materials at all times.

Exception: For new multi-story buildings, one of the required exit stairs may be obstructed on not more than two contiguous floor levels for the purposes of stairway construction (i.e., installation of gypsum board, painting, flooring, etc.).

Add: Section 3312.4 Required Means of Egress. All new buildings under construction shall have a least one unobstructed means of egress. All means of egress shall be identified in the Fire Protection Plan.

CHAPTER 49 – REQUIREMENTS FOR WILDLAND-URBAN INTERFACE AREAS

Section 4902 Definitions - Amend Section 4902 as follows:

Amend: FIRE HAZARD SEVERITY ZONE means those areas designated by the City of Oakland as Very High Fire Hazard Severity Zones in Oakland Municipal Code Chapter 15.12.

Amend: WILDLAND-URBAN INTERFACE is a geographical area identified by the state as a "Fire Hazard Severity Zone" in accordance with Public Resources Code Sections 4201 through 4204 and Government Code Sections 51176 through 51189, and includes those areas designated by the City of Oakland as Very High Fire Hazard Severity Zones in Oakland Municipal Code, Chapter 15.12.

Section 4903 Fire Protection Plans - Amend Section 4903 as follows:

Amend: 4903.1 General. When required by the Fire Code Official, a fire protection plan shall be prepared.

Amend: 4903.2 Content. The plan shall be based upon a site-specific wildfire risk assessment that includes considerations of location, topography, aspect, flammable vegetation, climatic conditions and fire

history. The plan shall address water supply, access, building ignition and fire-resistance factors, fire protection systems and equipment, defensible space and vegetation management.

Add: 4903.3 Cost. The cost of fire protection plan preparation and review shall be the responsibility of the applicant.

Add: 4903.4 Plan Retention. The fire protection plan shall be retained by the Fire Code Official.

Section 4904 (Fire Hazard Severity Zones) - Amend Section 4904 as follows:

Amend: 4904.3 General. Oakland Very High Fire Hazard Severity Zone. The Oakland Very High Fire Hazard Severity Zone is all of that area within the City, as defined by the Fire Code Official of the City of Oakland, including, but not limited to, the area north and east of the following boundaries:

BEGINNING at the MacArthur Freeway at the San Leandro boarder to Foothill Boulevard; west on Foothill Boulevard to Stanley; west on Stanley to 98th Avenue; south on 98th Avenue to Stearns Avenue; west on Stearns to Burr Street; west on Burr Street to Thermal; west on Thermal to 8500 Thermal; south at 8500 Thermal to MacArthur Boulevard; west on MacArthur Boulevard to 82nd Avenue; north on 82nd Avenue to Utah Street; west on Utah Street to Partridge Avenue; south on Partridge Avenue to Outlook Avenue; west on Outlook Avenue to Seminary Avenue; south on Seminary Avenue to MacArthur Boulevard; west on MacArthur Boulevard to Buell Street; north on Buell Street to Tompkins Avenue; west on Tompkins Avenue to End; straight line from Tompkins Avenue to Wisconsin Street; west on Wisconsin Street to Carlsen Street; west on Carlsen Street to Maple Avenue; south on Maple Avenue to Morgan Avenue; west on Morgan Avenue to Barner; south on Barner to Morgan Avenue; west on Morgan Avenue to Coolidge Avenue; North on Coolidge Avenue to Alida Street; west on Alida Street to Lincoln Avenue; south on Lincoln Avenue to Tiffin Road; west on Tiffin Road to Whittle Avenue; west on Whittle Avenue to Fruitvale Avenue (Dimond Park); follow the southern and western boundary of Dimond Park to El Centro Road; west on El Centro Road to Dolores; west on Dolores to Park Boulevard; north on Park Boulevard to Piedmont boundary; Piedmont boundary to Mt. View Cemetery; northern boundary of Mountain. View Cemetery to Clarewood Drive; west on Clarewood Drive to Broadway Terrace; south on Broadway Terrace to Margarido Drive; west on Margarido Drive to Lawton; west on Lawton to Broadway; north on Broadway to Keith Avenue; west on Keith Avenue to College Avenue; and north on College Avenue to the corporate limits of the City of Berkeley.

Section 4906 Hazardous Vegetation Management - Amend Section 4906 as follows:

Add: 4906.1.1 Scope, purpose and enforcement. Vegetation constituting a fire hazard shall be controlled according to Chapter 49 of this Code. At least one time annually the Fire Code Official shall cause a notice to be mailed to property owners advising them of potential conditions to be abated. Thereafter the Fire Code Official shall execute on-site inspections of properties within the Oakland Very High Fire Hazard Severity Zone, as described in Section 4904.3 of this code, for a determination of specific fire hazard conditions.

Add: 4906.1.2 Prohibition. No person who has any ownership or possessory interest in, or control of a parcel of land shall allow to exist thereon vegetation, which, by reason of proximity to a building or structure, constitutes a fire hazard.

Add: 4906.1.3 Specific requirements. In order to provide sufficient defensible space, each person who has any ownership or possessory interest in, or control of, a parcel of land shall do all of the following:

Add: 4906.1.3.1 General. All properties within the Oakland Very High Fire Hazard Severity Zone must maintain defensible space around all buildings and structures as provided in Section 4907 of this code as amended.

Add: 4906.1.3.4 Violations and Corrective Actions. Violations shall be addressed in accordance with Chapter 1, Sections 109 and 114 of this code.

Section 4907 Defensible Space - Amend Section 4907 as follows:

Add: 4907.4 Defensible Space. Persons owning, leasing, controlling, operating or maintaining buildings or structures in, upon or adjoining the Wildland-Urban Interface Fire Area and persons owning, leasing or controlling land adjacent to such buildings or structures, shall:

Maintain an effective 30-foot defensible space by removing and clearing away flammable vegetation and combustible growth from structures.

Exception: Single specimens of trees, ornamental shrubbery or similar plants used as ground covers, provided that they do not form a means of rapidly transmitting fire from the native growth to any structure.

Add: 4907.5 Additional Defensible Space. Maintain additional effective defensible space by removing brush, flammable vegetation and other combustible growth located 30 feet to 100 feet from such buildings or structures, when required by the Fire Code Official due to steepness of terrain or other conditions that would cause a defensible space of only 30 feet to be insufficient.

Exception: Grass and other vegetation located more than 30 feet from buildings or structures and less than 18 inches in height above the ground need not be removed where necessary to stabilize the soil and prevent erosion.

Add: 4907.5.1 Trees. Trees within the designated defensible space area shall be maintained in accordance with 4907.3.1.1 thru 4907.3.1.4.

Add: 4907.5.1.1 Tree crowns extending to within 10 feet of any structure shall be pruned to maintain a minimum horizontal clearance of 10 feet.

Add: 4907.5.1.2 Portions of tree crowns that extend within 10 feet of the outlet of a chimney shall be pruned to maintain a minimum horizontal clearance of 10 feet.

Add: 4907.5.1.3 Trees within the defensible space shall be pruned to remove limbs located less than 6 feet above the ground surface.

Add: 4907.5.1.4 Deadwood and litter shall be regularly removed from trees.

Add: 4907.5.2 Clearance of Brush or Vegetative Growth from Roadways. The Fire Code Official is authorized to require areas within 10 feet on each side of portions of fire apparatus access roads and driveways to be cleared of non-fire-resistive vegetation growth.

Exception: Single specimens of trees, ornamental vegetative fuels or cultivated ground cover, such as green grass, ivy, succulents or similar plants used as ground cover, provided they do not form a means of readily transmitting fire.

Add: 4907.5.3 Combustible fences. Maintain all hazardous vegetation located within ten (10) feet (3048 mm) of any combustible fence.

Add: 4907.5.4 Cut vegetation and refuse. Remove and/or safely dispose of all cut vegetation and hazardous refuse. Cut grass may be left on the slope to protect the soil if it lays down within three (3) inches (76 mm) of the ground. Cut vegetation may be chipped or mulched and left on the slope up to a depth of 12 inches (30 mm).

Add: 4907.5.5 Soil erosion control. If the abatement of vegetation results in the exposure of bare mineral soil, or the soil is exposed to such an extent that increased soil erosion would be likely, or the Fire Code Official determines that the abatement has been excessive and poses a threat to the public health, safety or welfare, irrigation and landscaping or a suitable erosion control structure must be provided to establish effective soil erosion control.

Add: 4907.5.6 Minimum requirements. Nothing contained in this Section shall be deemed to preclude the Fire Code Official from requiring more than the minimum specific requirements set forth above when the Fire Code Official determines that conditions exist that necessitates greater fire protection measures.

Add: 4907.5.7 Corrective Actions. The Fire Code Official is authorized to give notice to the owner of the property upon which conditions regulated by Section 4907.1.3 exist to correct such conditions. If the owner fails to correct such conditions, the City of Oakland is authorized to cause the same to be done and make the expense of such correction a lien upon the property where such condition exists.

Add: Section 4907.6 Access

Add: 4907.6.1 General. Buildings and structures, or portions thereof, hereafter constructed or relocated into or within Wildland-Urban Interface Fire Areas shall be provided with fire apparatus access in accordance with this Chapter.

Add: 4907.6.2 Driveways. Driveways shall be provided when any portion of an exterior wall of the first story of a building is located more than 150 feet from a fire apparatus access road in accordance with 4907.3.2.1 thru 4907.3.2.8.

Add: 4907.6.2.1 Driveways shall be an all-weather surface and shall provide a minimum unobstructed width of 12 feet and a minimum unobstructed height of 13 feet 6 inches.

Add: 4907.6.2.2 Driveways in excess of 150 feet in length shall be provided with turnarounds.

Add: 4907.6.2.3 Driveways in excess of 200 feet in length and less than 20 feet in width shall be provided with turnouts in addition to turnarounds.

Add: 4907.6.2.4 A driveway shall not serve in excess of two dwelling units.

Exception: When such driveways meet the requirements for an access road in accordance with this Chapter.

Add: 4907.6.2.5 Driveway turnarounds shall be in accordance with Fire Department standards.

Add: 4907.6.2.6 Driveways that connect with a road or roads at more than one point may be considered as having a turnaround if all changes of direction meet the radius requirements for driveway turnarounds.

Add: 4907.6.2.7 Driveway turnouts shall be an all-weather road surface at least 8 feet wide and 30 feet long. Driveway turnouts shall be located as required by the code official.

Add: 4907.6.2.8 Vehicle load limits shall be posted at both entrances to bridges on driveways and private roads. Design loads for bridges shall be established by the code official.

Add: 4907.7 Fire Apparatus Access Roads. Fire apparatus access roads shall be all weather roads with a minimum width of 20 feet and a clear height of 13 feet 6 inches; and shall be designed in accordance with Fire Apparatus Access Roads Appendix D.

Section 4911 Water Supply - Amend Section 4911 as follows:

Add: 4911.1 General. Buildings and structures, or portions thereof, hereafter constructed or relocated into or within Wildland-Urban Interface Fire Areas shall be provided with fire protection water supplies in accordance with this Chapter.

Exception: Buildings containing only private garages, carports, sheds and agricultural buildings with a building area of not more than 500 square feet.

Add: 4911.2 Water Sources. The point at which a water source is available for use shall be located not more than 600 feet from all portions of the exterior walls of the building and be approved by the code official. The distance shall be measured along an unobstructed line of travel.

Water sources shall have a minimum usable water volume as determined by the adequate water supply needs in accordance with Section 4914.4. This water source shall be equipped with an approved hydrant. The water source shall be provided and maintained by a recognized water purveyor, mutual water company or water pumped from a well. The design, construction, location, water level maintenance, access, and access maintenance of manmade water sources shall be approved by the code official.

Add: 4911.3 Hydrants. All hydrants shall be designed and constructed in accordance with nationally-recognized standards. The location and access shall be approved by the code official.

Add: 4911.4 Adequate Water Supply. Adequate fire protection water supplies shall be as follows:

1. **One- And Two-Family Dwellings.** The required fire protection water supply for one- and two-family dwellings shall be in accordance with Appendix B. The water supply duration need not exceed 30 minutes.
2. **Buildings Other Than One- and Two-Family Dwellings.** The water supply required for other than one- and two-family dwellings shall be in accordance with Appendix B.

Exception: The water supply duration need not exceed 2 hours.

Add: 4911.5 Obstructions. Access to all water sources required by this code shall be unobstructed at all times. The code official shall not be deterred or hindered from gaining immediate access to water source equipment, fire protection equipment or hydrants.

Add: 4911.6 Identification. Water sources, hydrants and fire protection equipment shall be clearly identified in a manner approved by the code official to identify location and to prevent obstruction by parking and other obstructions.

Add: 4911.7 Testing and Maintenance. Water sources, hydrants and other fire protection equipment required by this code shall be subject to periodic tests as required by the code official. All such equipment installed under the provisions of this code shall be maintained in an operative condition at all times and shall be repaired or replaced where defective. Additions, repairs, alterations and servicing of such fire protection equipment and resources shall be in accordance with approved standards.

Add: 4911.8 Clearance of Fuel. Defensible space shall be provided around water tank structures, water supply pumps and pump houses in accordance with Section 4907.

Add: 4911.9 Standby Power. Stationary water supply facilities within the Wildland-Urban Interface Fire Areas dependent on electrical power to meet adequate water supply demands shall provide standby power systems in accordance with the Electrical Code to ensure that an uninterrupted water supply is maintained. The standby power source shall be capable of providing power for a minimum of two hours.

Exceptions:

- (a). When approved by the Fire Code Official, a standby power supply is not required where the primary power service to the stationary water supply facility is underground.
- (b). A standby power supply is not required where the stationary water supply facility serves no more than one single-family dwelling.

Section 4912. General Requirements for Suppression and Control - Add Section 4912 as follows:

Add: 4912.1 Scope. The provisions of this Section establish general requirements applicable to new and existing properties located within the Wildland-Urban Interface Fire Areas.

Add: 4912.2 Objective. The objective of this Chapter is to provide necessary fire-protection measures to reduce the threat of wildfire in the Wildland-Urban Interface Fire Areas and improve the capability of controlling such fires.

Add: 4912.3 Restricted Entry to Public Lands. The Fire Code Official is authorized to determine and publicly announce when Wildland-Urban Interface Fire Areas shall be closed to entry and when such areas shall again be opened to entry. Entry on and occupation of Wildland-Urban Interface Fire Areas, except public roadways, inhabited areas or established trails and campsites that have not been closed during such time when the Wildland-Urban Interface Fire Areas is closed to entry, is prohibited.

Exceptions:

- (a). Residents and owners of private property within Wildland-Urban Interface Fire Areas and their invitees and guests going to or being on their lands.
- (b). Entry, in the course of duty, by peace or police officers, and other duly authorized public officers, members of a fire department and members of the Wildland Firefighting Service.

Add: 4912.4 Trespassing On Posted Private Property.

Add: 4912.4.1 General. When the Fire Code Official determines that a specific area within a Wildland-Urban Interface Fire Areas presents an exceptional and continuing fire danger because of the density of natural growth, difficulty of terrain, proximity to structures or accessibility to the public, such areas shall be restricted or closed until changed conditions warrant termination of such restriction or closure. Signs shall be posted in such areas in accordance with Section 4909.4.2.

Add: 4912.4.2 Signs. Approved signs prohibiting entry by unauthorized persons and referring to this code shall be placed on every closed area.

Add: 4912.4.3 Trespassing. Entering and remaining within areas closed and posted is prohibited.

Exception: Owners and occupiers of private or public property within closed and posted areas; their guests or invitees; authorized persons engaged in the operation and maintenance of necessary utilities such as electrical power, gas, telephone, water and sewer; and local, state and federal public officers and their authorized agents acting in the course of duty.

Add: 4912.5 Use of Fire Roads and Defensible Space. Motorcycles, motor scooters and motor vehicles shall not be driven or parked on, and trespassing is prohibited on, fire roads or defensible space beyond the point where travel is restricted by a cable, gate or sign, without the permission of the property owners. Vehicles shall not be parked in a manner that obstructs the entrance to a fire road or defensible space.

Exception: Public officers acting within their scope of duty. Radio and television aerials, guy wires thereto, and other obstructions shall not be installed or maintained on fire roads or defensible spaces, unless located 16 feet (4877 mm) or more above such fire road or defensible space.

Add: 4912.6 Use of Motorcycles, Motor Scooters, Ultralight Aircraft and Motor Vehicles.

Motorcycles, motor scooters, ultra-light aircraft and motor vehicles shall not be operated within Wildland-Urban Interface Fire Areas, without a permit by the code official, except on clearly established public or private roads. Permission from the property owner shall be presented when requesting a permit.

Add: 4912.7 Tampering With Locks, Barricades, Signs and Address Markers. Locks, barricades, seals, cables, signs and address markers installed within Wildland-Urban Interface Fire Areas, by or under the control of the code official, shall not be tampered with, mutilated, destroyed or removed.

Gates, doors, barriers and locks installed by or under the control of the code official shall not be unlocked.

Add: 4912.8 Ignition Source Control

Add: 4912.8.1 General. Ignition sources shall be in accordance with Section 4909.8.

Add: 4912.8.2 Objective. Regulations in this Section are intended to provide the minimum requirements to prevent the occurrence of wildfires.

Add: 4912.8.3 Clearance from Ignition Sources. Clearance between ignition sources and grass, brush or other combustible materials shall be maintained a minimum of 30 feet.

Add: 4912.8.4 Smoking. When required by the code official, signs shall be posted stating NO SMOKING. No person shall smoke within 15 feet of combustible materials or non-fire-resistive vegetation.

Exception: Places of habitation or in the boundaries of established smoking areas or campsites as designated by the code official.

Add: 4912.8.5 Equipment and Devices Generating Heat, Sparks or Open Flames. Equipment and devices generating heat, sparks or open flames capable of igniting nearby combustibles shall not be used in Wildland-Urban Interface Fire Areas without a permit from the code official.

Exception: Use of approved equipment in habituated premises or designated campsites that are a minimum of 30 feet (9144 mm) from grass-, grain-, brush- or forest-covered areas.

Add: 4912.9 Fireworks. Fireworks shall not be used or possessed in Wildland-Urban Interface Fire Areas.

Add: 4912.10 Outdoor Fires.

Add: 4912.10.1 General. No person shall build, ignite or maintain any outdoor fire of any kind for any purpose in or on any Wildland-Urban Interface Fire Areas or very High Fire Severity Zones, except by the authority of a written permit from the Fire Code Official. Shall also apply to Red Flag Days.

Exception: Outdoor fires within inhabited premises or designated campsites where such fires are in a permanent barbecue, portable barbecue, outdoor fireplace or grill and are a minimum of 30 feet from any combustible material or non-fire-resistive vegetation.

Add: 4912.11 Reckless Behavior. The code official is authorized to stop any actions of a person or persons if the Fire Code Official determines that the action is reckless and could result in an ignition of fire or spread of fire.

Add: 4912.12 Control of Storage. In addition to the requirements of the California Fire Code, storage and use of combustible materials shall be in accordance with Section 4909.5.

Add: 4912.12.1 Outside storage of combustible materials such as, but not limited to, wood, rubber tires, Fire materials or paper products shall comply with the other applicable sections of this code and this Section.

Add: 4912.13 Storage of Firewood and Combustible Materials. Firewood and combustible material shall not be stored in unenclosed spaces beneath buildings or structures, on or below decks or under eaves, canopies or other projections or overhangs. When required by the Fire Code official, storage of firewood and combustible material stored in the defensible space shall be located a minimum of 20 feet from structures and separated from the crown of trees by a minimum horizontal distance of 15 feet.

Add: 4912.13.1 Storage for Off-Site Use. Firewood and combustible materials intended for off-site use shall be stored so as to not pose a hazard.

Add: 4912.14 Dumping. Waste material shall not be placed, deposited or dumped in Wildland-Urban Interface Fire Areas or in, on or along trails, roadways or highways or against structures.

Exception: Approved public and approved private dumping areas.

Add: 4912.15 Ashes and Coals. Ashes and coals shall not be placed, deposited or dumped in combustible containers in the Wildland-Urban Interface Fire Areas.

Exceptions:

- (a). In the hearth of an established fire pit, camp stove or fireplace.
- (b). In a noncombustible container with a tight fitting lid, which is kept or maintained in a safe location not less than 10 feet from non-fire-resistive vegetation or structures.
- (c). Where such ashes or coals are buried and covered with 1 foot of mineral earth not less than 25 feet from non-fire-resistive vegetation or structures.

Add: 4912.16 Objective. The increased public use of land or structures in Very High Fire Hazard Severity Zone also increases the potential threat to life safety. The provisions of this Section are intended to reduce that threat.

Add: 4912.16.1 Permits. Temporary fairs, carnivals, public exhibitions or similar uses shall not be allowed in a designated Very High Fire Hazard Severity Zone, except by permit from the code official. Permits shall incorporate such terms and conditions that will reasonably safeguard public safety and property.

Add: 4912.17 Automatic Fire Sprinkler System. Buildings and structures located in Very High Fire Severity Zones shall be provided with automatic fire sprinkler protection in accordance with Sections 4909.9.1 and 4909.9.2.

Add: 4912.17.1 The Electrical Energy Storage system shall provide an automatic fire sprinkler system or an approved and tested portable extinguishing system

Add: 4912.17.1 New Facilities. An approved automatic fire sprinkler system shall be provided throughout all new facilities located in the Wildland-Urban Interface Fire Areas.

Exception: Accessory structures to single-family residences that are non-residential and that have a gross floor area of 500 square feet or less.

Add: 4912.17.2 Existing Facilities. An approved automatic fire sprinkler system shall be provided throughout all existing facilities/residential buildings located in the Wildland-Urban Interface Fire Areas when modifications are over 500 square feet or when modifications are made that increase the gross floor area greater than 50% or when the modification exceeds 3,600 square feet. Exceptions from 903.2.21 are not permitted for wildland-urban interface areas.

Exception: One-time additions to existing occupancies made after January 1, 2008 that do not exceed 500 square feet in gross floor area.

CHAPTER 50 HAZARDOUS MATERIALS - GENERAL PROVISIONS

Section 5003 General Requirements - Amend Section 5003 as follows:

Add: 5003.2.10 Fire Protection for Workstations. When the building is protected by an automatic fire sprinkler system, additional sprinkler protection in accordance with Section 5003.10 shall be provided for all combustible workstations where hazardous materials are dispensed, stored or used.

Exception: Internal fire protection is not required for Biological Safety Cabinets that carry NSF/ANSI certification and where aggregate quantities of flammable liquids in use or storage within the cabinet do not exceed 500ml.

The Fire Code Official may approve alternate automatic fire-extinguishing systems. Activation of such systems shall deactivate the related processing equipment. An alternative automatic fire-extinguishing system other than automatic fire sprinkler heads may be installed where:

- (a). In process equipment that operates at temperatures exceeding 932 degrees F (500 degrees C).
- (b). In exhaust ducts 10 inches (254 mm) or less in diameter for flammable gas storage cabinets that are part of a workstation.

Exception: Piping and tubing within the space defined by the walls of corridors and the floor or roof above or in concealed space above other occupancies when installed in accordance with Section 415.11 of the California Building Code as required for Group H, Division 5 Occupancies.

- (c). All primary piping for toxic, highly toxic and moderately toxic gases shall pass a helium leak test of 1x10⁻⁹ cubic centimeters/second where practical, or shall pass testing in accordance with an approved, nationally recognized standard. Tests shall be conducted by a qualified "third party" not involved with the construction of the piping and control systems.

Add: 5003.5.2 Ventilation Ducting. Product conveying ducts for venting hazardous materials operations shall be labeled with the hazard class of the material being vented and the direction of flow.

Add: 5003.5.3 "H" Occupancies. In "H" occupancies, all piping and tubing may be required to be identified when there is any possibility of confusion with hazardous materials transport tubing or piping. Flow direction indicators are required.

Add: 5003.9.11 Monitoring. Liquid and solid hazardous materials storage or use systems must be monitored on a regular or continuous basis. A written monitoring plan must be submitted for approval by the Fire Code Official and must be included in the Hazardous Materials Business Plan. Monitoring methods may include but are not limited to the following:

1. Visual inspection, no less than monthly (requires trained personnel and documentation).
2. Approved continuous leak detection and alarm system.
3. Any system which will provide continuous, reliable monitoring of the primary container(s) capable of alerting occupants to an alarm or trouble condition; all systems are subject to approval by the Fire Code Official.

Add: 5003.9.12 Spill Control for hazardous materials liquids. Regardless of the exempt amounts and containment requirements in Chapter 50, all containers of liquid hazardous materials regulated by this or any other article shall be provided with an approved means to control spills. The spill control shall take into consideration the amount and hazard of the materials and the nature of the facility.

Add: 5003.9.13 Secondary Containment requirements. When deemed necessary to protect life safety, emergency responders, or the environment and regardless of the exempt amounts and secondary containment requirements in Chapter 50, the Fire Code Official, or his designee, may require containers of liquid, solid, or gaseous hazardous materials regulated by this or any other article to be provided with secondary containment in accordance with Section 5004.2.2.

If parts of this code differ in their requirements for secondary containment, the more stringent shall apply. The chief may require outside containment areas to be covered with a roof or canopy for protection from the environment.

Amend: 5003.10.4.3 Toxic, highly toxic and asphyxiant gases shall be limited to a container of a maximum water capacity of 1 lb.

Section 5004 Storage - Amend Section 5004 as follows:

Amend: 5004.2.1 Spill control for hazardous materials liquids. Rooms, buildings or areas used for the storage of hazardous materials in excess of their permit amount or fifty-five (55) gallons, whichever is less, shall be provided with spill control to prevent the flow of liquids to adjoining areas. Floors in indoor locations and similar surfaces in outdoor locations shall be constructed to contain a spill from the largest single vessel by one of the following methods:

1. Liquid-tight sloped or recessed floors in indoor locations or similar areas in outdoor locations.
2. Liquid-tight floors in indoor locations or similar areas in outdoor locations provided with liquid-tight raised or recessed sills or dikes.
3. Sumps and collection systems.
4. Other approved engineered systems.

Except for surfacing, the floors, sills, dikes, sumps and collection systems shall be constructed of noncombustible material, and the liquid-tight seal shall be compatible with the material stored. When liquid-tight sills or dikes are provided, they are not required at perimeter openings that are provided with an open-gate trench across the opening that connects to an approved collection system.

Amend: 5004.2.2 Secondary containment for hazardous materials liquids and solids.

Buildings, rooms or areas used for the storage of hazardous materials liquids or solids shall be provided with secondary containment in accordance with this Section when the capacity of an individual vessel or the aggregate capacity of multiple vessels exceeds the following:

1. Liquids: Capacity of an individual vessel exceeds 55 gallons (208.2L) or the aggregate capacity of multiple vessels exceeds 1,000 gallons (3,785L); and
2. Solids: Capacity of an individual vessel exceeds 550 pounds (248.8 kg) or the aggregate capacity of multiple vessels exceeds 10,000 pounds (4,524.8 kg).

CHAPTER 53 - COMPRESSED GASES

Section 5307 Compressed Gases Not Otherwise Regulated - Amend Section 5307 as follows:

Add: 5307.4.8 Existing facilities. An existing carbon dioxide enrichment system shall be installed in accordance with Section 5307.4 within a timeframe established by the adopting authority.

CHAPTER 56 - EXPLOSIVES AND FIREWORKS

Section 5601 General - Amend Section 5601 as follows:

Amend: 5601.1 Scope. The provisions of this Chapter shall govern the possession, manufacture, storage, handling, sale and use of explosives, explosive materials, fireworks, rockets, emergency signaling devices and small arms ammunition. Please also refer to Oakland Municipal Code Chapter 8.06.

Exceptions:

- (a). The Armed Forces of the United States, Coast Guard or National Guard.
- (b). Explosives in forms prescribed by the official United States Pharmacopoeia.
- (c). The possession, storage and use of small arms ammunition when packaged in accordance with DOT packaging requirements.
- (d). The possession, storage and use of not more than 1 pound (0.454kg) of commercially manufactured sporting black powder, 20 pounds (9 kg) of smokeless powder and 10,000 small arms primers for hand loading of small arms ammunition for personal consumption.

- (e). The use of explosive materials by federal, state and local regulatory, law enforcement and fire agencies acting in their official capacities.
- (f). Special industrial explosive devices which in the aggregate contain less than 50 pounds (23 kg) of explosive materials.
- (g). The possession, storage and use of blank industrial-power load cartridges when packaged in accordance with DOT packaging regulations.
- (h). Transportation in accordance with DOT 49 CFR Parts 100 - 185
- (i). Items preempted by federal regulations.
- (j). Items preempted by state law and/or local regulations.

Add: 5601.1.1.1 Explosives. The possession, manufacture, storage, sale, handling, and use of explosives are prohibited.

Exceptions:

- (a). Possession, storage, handling and use of explosives for test and research purposes are allowed with permit and approval of the Fire Code Official.
- (b). Possession, storage, handling and use of squibs, explosive nuts or bolts and similar small quantity explosive devices are allowed with permit and approval of the Fire Code Official.

Amend: 5601.1.3 Fireworks. As specified in Chapter 8.06 of the Oakland Municipal Code, the possession, manufacture, storage, sale, handling, and use of fireworks, including those fireworks classified as Safe and Sane by the California State Fire Marshal, are prohibited.

Exceptions:

- (a). Storage and handling of fireworks as allowed in Section 5604.
- (b). Manufacture, assembly and testing of fireworks as allowed in Section 5605 and Health and Safety Code Division 11.
- (c). A permit issued by the Fire Code Official is required according to California Fire Code Chapter 105 for the use of fireworks for firework displays, pyrotechnics before a proximate audience and Storage, handling and use of fireworks and pyrotechnic special effects when used for public or proximate audience displays, in motion pictures, television, theatrical and or group entertainment productions. Permitted fireworks shall be handled and used by a licensed pyrotechnic operator in accordance with Title 19, Division 1, Chapter 6 Fireworks reprinted in Section 5608 of the California Code of Regulations and permitted in accordance with this Chapter and Health and Safety Code Division 11.
- (d). A permit shall be issued by the Fire Code Official for storage, handling and use of pyrotechnic special effects fireworks inside of occupancies equipped throughout with an approved fire sprinkler system, when used for proximate audience displays or special effects in theatrical, television, motion picture and group entertainment productions and when handled and used by a licensed pyrotechnic operator in accordance with Title 19 of the California Code of Regulations and permitted in accordance with this Chapter.
- (e). Deleted.

Add: 5601.1.3.1 Model Rocketry. The storage, handling, and use of model rockets shall be in accordance with Title 19 of the California Code of Regulations and as approved by the Fire Code Official.

Amend: 5601.2.2 Sale and retail display. Sale, transfer, possession and use of fireworks prohibited. In accordance with Oakland Municipal Code 8.06.030.

CHAPTER 57 - FLAMMABLE AND COMBUSTIBLE LIQUIDS

Section 5701 General - Amend Section 5701 as follows:

Add: 5701.4.1 Plans. Plans shall be submitted with each application for a permit to store liquids outside of buildings in drums or tanks. The plans shall indicate the method of storage, quantities to be stored, distances from buildings and property lines, access ways, fire-protection facilities, and provisions for spill control and secondary containment.

All plans and specifications shall be approved by Alameda County Environmental Health Services.

Section 5707 On-Demand Mobile Fueling Operations — Amend Section 5707 as follows:

Amend: 5707.5.2 Break-away device. A listed break-away device shall be provided at the nozzle. NFPA 30A 14.3.3.

Add: 5707.5.6 Fuel pump. The fuel pump shall be listed to UL 79, Power Operated Pumps for Petroleum Dispensing Product . NFPA 30A 14.3.6.

Add: 5707.5.7 Fuel meter. The meter shall be listed to UL 25, Meters for Flammable and Combustible Liquids and LP-Gas . NFPA 30A 14.3.7.

Add: 5707.6.7 Nighttime deliveries. Nighttime deliveries shall only be made in areas deemed adequately lighted by the authority having jurisdiction. NFPA 30A 14.4.1.

Add: 5707.6.8 Vehicle lights. The mobile fueling vehicle flasher lights shall be in operation while dispensing operations are in progress. NFPA 30A 14.4.2.

Add: 5707.6.9 Safety cones. Safety cones or barriers shall be employed to protect the vehicle fueling area. NFPA 30A 14.4.3.

Add: 5707.6.10 Expansion space. Expansion space shall be left in each motor vehicle fuel tank to prevent overflow in the event of temperature increase. NFPA 30A 14.4.4.

Add: 5707.6.11 Bonding. A means for bonding the mobile fueling vehicle to the motor vehicle shall be provided. Such bonding means shall be employed during fueling operations. NFPA 30A 14.4.5 *.

A.14.4.5 The listed hose and nozzle assembly provides for bonding. However, where there is a plastic insert that prohibits an electrical/metallic connection with the customer vehicle while filling, then a separate means of bonding is required.

CHAPTER 58 - FLAMMABLE GASES AND FLAMMABLE CRYOGENIC FLUIDS

Section 5803 General Requirements — Amend Section 5803 as follows:

Add: 5803.3 Mobile gaseous fueling of hydrogen-fueled vehicles. Mobile fueling of hydrogen vehicles is prohibited unless approved by the Fire Code Official.

CHAPTER 60 - HIGHLY TOXIC AND TOXIC MATERIALS

Section 6002 Definitions — Amend Section 6002 as follows:

Add: MODERATELY TOXIC GAS. Moderately toxic gas is a chemical or substance that has a median lethal concentration (LC₅₀) in air more than 2000 parts per million but not more than 5000 parts per million by volume of gas or vapor, when administered by continuous inhalation for an hour, or less if death occurs within one hour, to albino rats weighing between 200 and 300 grams each.

Maximum Threshold Quantity (Max TQ) is the maximum quantity of a moderately toxic or toxic gas, which may be stored in a single vessel before a more stringent category of regulation is applied. The following equation shall be used to calculate the Max TQ:

$$\text{Max TQ (pounds)} = \text{LC}_{50} \text{ (ppm)} \times 2 \text{ lb.}$$

Gas Mixtures, the LC₅₀ value for a gas mixture containing toxic, highly toxic or moderately toxic components shall be calculated using the formula in Appendix E, Section 103.1.3.1.

Section 6004 Highly Toxic and Toxic Compressed Gases Including Those Used as Refrigerants —
Amend Section 6004 as follows:

Amend: 6004.1 General. The storage and use of highly toxic and toxic compressed gases and those with health hazard rankings of 3 or 4 in accordance with NFPA 49 or NFPA704 shall comply with this Section.

Add: 6004.1.1.4 Other areas of Group B, F, M, S or L occupancies. Storage, use, and handling of highly toxic and toxic compressed gases shall comply with the following:

1. When located inside, highly toxic and toxic compressed gases shall be permitted, stored or used only when located within approved gas cabinets, exhausted enclosures, or gas rooms. See also Sections 6004.1.2, 6004.1.3, and 6004.2.2.6.

Exceptions:

- 1.1 Cylinders of compressed gases with a health hazard ranking of 4 and with a capacity not exceeding 10 cubic feet at normal temperature and pressure (NTP) are allowed in gas cabinets or fume hoods.
- 1.2 Cylinders of compressed gases with a health hazard ranking of 3 and with a capacity not exceeding 20 cubic feet at normal temperature and pressure (NTP) are allowed in gas cabinets, fume hoods or approved tools designed for their use.
2. When located outside, and when approved by the Fire Code Official, highly toxic and toxic compressed gases shall be kept under a canopy in accordance with Section 6004.3.3.

Add: 6004.1.4 Automatic Shut-Off Valve. An automatic shut-off valve, which is of a fail-safe-to-close design, shall be provided to shut off the supply of highly toxic gases for any of the following:

1. Activation of a manual fire alarm system.
2. Activation of the gas detection system.
3. Failure of emergency power.
4. Failure of primary containment.
5. Seismic activity.
6. Failure of required ventilation.
7. Manual activation at an approved remote location.

Add: 6004.1.5 Emergency Control Station. Signals from emergency equipment used for highly toxic gases shall be transmitted to an emergency control station or other approved monitoring station, which is continually staffed by trained personnel.

Add: 6004.1.6 Maximum Threshold Quantity. Toxic gases stored or used in quantities exceeding the maximum threshold quantity in a single vessel per control area or outdoor control area shall comply with the additional requirements for highly toxic gases of Section 6004 of this code.

Moderately toxic gases stored or used in quantities exceeding the maximum threshold quantity. In a single vessel per control area or outdoor control area shall comply with the additional requirements for toxic gases of Section 6004 of this code.

Add: 6004.1.7 Reduced Flow Valve. All containers of materials other than lecture bottles containing Highly Toxic material and having a vapor pressure exceeding 29 psi shall be equipped with a reduced flow valve when available. If a reduced flow valve is not available, the container shall be used with a flow-limiting device. All flow limiting devices shall be part of the valve assembly and visible to the eye when possible; otherwise, they shall be installed as close as possible to the cylinder source.

Add: 6004.1.8 Annual Maintenance. All safety control systems at a facility shall be maintained in good working condition and tested not less frequently than annually. Maintenance and testing shall be performed by persons qualified to perform the maintenance and tests. Maintenance records and certifications shall be available to any representative of the Fire Department for inspection upon request.

Add: 6004.1.9 Fire Extinguishing Systems. Fires and covered exterior areas for storage and use areas of materials regulated by this Chapter shall be protected by an automatic fire sprinkler system in accordance with NFPA 13. The design of the sprinkler system for any room or area where highly toxic, toxic and moderately toxic gases are stored, handled or used shall be in accordance with Section 5004.5.

Add: 6004.1.10 Local Gas Shut Off. Manual activation controls shall be provided at locations near the point of use and near the source, as approved by the Fire Code Official. The Fire Code Official may require additional controls at other places, including, but not limited to, the entry to the building, storage or use areas, and emergency control stations. Manual activated shut-off valves shall be of a "fail safe-to-close design."

Add: 6004.1.11 Exhaust Ventilation Monitoring. For highly toxic gases and toxic gases exceeding threshold quantities, a continuous monitoring system shall be provided to assure that the required exhaust ventilation rate is maintained. The monitoring system shall initiate a local alarm. The alarm shall be both visual and audible and shall be designed to provide warning both inside and outside of the interior storage, use, or handling area.

Add: 6004.1.12 Emergency Response Plan. If the preparation of an emergency response plan for the facility is not required by any other law, responsible persons shall prepare, or cause to be prepared, and filed with the Fire Code Official, a written emergency response plan. If the preparation of an emergency response plan is required by other law, a responsible person shall file a copy of the plan with the Fire Code Official.

Add: 6004.1.13 Emergency Response Team. Responsible persons shall be designated the on-site emergency response team and trained to be liaison personnel for the Fire Department. These persons shall aid the Fire Department in preplanning emergency responses, identifying locations where regulated materials are stored, handled and used, and be familiar with the chemical nature of such material. An adequate number of personnel for each work shift shall be designated.

Add: 6004.1.14 Emergency Drills. Emergency drills of the on-site emergency response team shall be conducted on a regular basis but not less than once every three months. Records of drills conducted shall be maintained. **Add: 6004.1.15 Cylinder Leak Testing.** Cylinders shall be tested for leaks immediately upon delivery and again immediately prior to departure. Testing shall be approved by the Fire Code Official in accordance with appropriate nationally recognized industry standards and practices, if any. Appropriate remedial action shall be immediately undertaken when leaks are detected.

Add: 6004.1.16 Inert Gas Purge System. Gas systems shall be provided with dedicated inert gas purge systems. A dedicated inert gas purge system may be used to purge more than one gas, provided the gases are compatible. Purge gas systems inside buildings shall be located in an approved gas cabinet unless the system operates by vacuum demand.

Add: 6004.1.17 Seismic Shutoff Valve. An automatic seismic shut-off valve, which is of a fail-safe-to-close design, shall be provided to shutoff the supply of highly toxic and toxic and moderately toxic gases with an LC₅₀ less than 3000 parts per million upon a seismic event within 5 seconds of a horizontal sinusoidal oscillation having a peak acceleration of 0.3G (1.47m/sec²) and a period of 0.4 seconds.

Amend: 6004.2 Indoor Storage and Use. The indoor storage or use of highly toxic and moderately toxic compressed gases shall be in accordance with Sections 6004.2.1 through 6004.2.2.10.3.3. The threshold quantity for highly toxic, toxic and moderately toxic gases for indoor storage and use are set forth in Table 6004.2.

Add: Table 6004.2 to read:

Threshold Quantities for Highly Toxic, Toxic and Moderately Toxic Gases for Indoor Storage and Use	
Highly Toxic	0
Toxic	10 cubic feet
Moderately Toxic	20 cubic feet

Amend: 6004.2.1 Applicability. The applicability of regulations governing the indoor storage and use of highly toxic, toxic, and moderately toxic compressed gases shall be as set forth in Sections 6004.2.1.1 through 6004.2.1.3.

Amend: 6004.2.1.1 Quantities Not Exceeding the Maximum Allowable Quantity per Control Area. The indoor storage or use of highly toxic, and moderately toxic gases in amounts exceeding the threshold quantity per control area set forth in Table 6004.2 shall be in accordance with Sections 5001, 5003, 6001, 6004.1 and 6004.2.

Amend: 6004.2.2 General Indoor Requirements. The general requirements applicable to the indoor storage and use of highly toxic and toxic compressed gases shall be in accordance with Sections 6004.2.2.1 through 6004.2.2.10.3.

Moderately toxic gases with an LC₅₀ less than 3000 parts per million shall comply with the requirements for toxic gases in Sections 6004.2.2.1 through 6004.2.2.10.3.

All other moderately toxic gases exceeding the threshold quantity shall comply with the requirements for toxic gases in Sections 6004.2.2.1 through 6004.2.2.7.

Amend: 6004.2.2.7 Treatment Systems. The exhaust ventilation from gas cabinets, exhausted enclosures, gas rooms and local exhaust systems required in Section 3704.2.2.4 and 3704.2.2.5 shall be directed to a treatment system. The treatment system shall be utilized to handle the accidental release of gas and to process exhaust ventilation. The treatment system shall be designed in accordance with Sections 3704.2.2.7.1 through 3704.2.2.7.5 and Section 510 of the California Mechanical Code.

Exceptions:

1. Highly toxic, toxic and moderately toxic gases storage. A treatment system is not required for cylinders, containers and tanks in storage when all of the following are provided:
 - 1.1. Valve outlets are equipped with gas-tight outlet plug or caps.
 - 1.2. Hand wheel-operated valves have handles secured to prevent movement.
 - 1.3. Approved containment vessels or containment systems are provided in accordance with Section 3704.2.2.3.

Amend: 6004.3 Outdoor Storage and Use. The outdoor storage or use of highly toxic and moderately toxic compressed gases shall be in accordance with Sections 6004.3.1 through 6004.3.4. The threshold quantity for highly toxic, toxic and moderately toxic gases for outdoor storage and use are set forth in Table 6004.3.

Add: Table 6004.3 to read:

Threshold Quantities for Highly Toxic, Toxic and Moderately Toxic Gases for Outdoor Storage and Use	
Highly Toxic	0
Toxic	10 cubic feet
Moderately Toxic	20 cubic feet

Amend: 6004.3.1 Applicability. The applicability of regulations governing the outdoor storage and use of highly toxic, toxic, and moderately toxic compressed gases shall be as set forth in Sections 6004.3.1.1 through 6004.3.1.3.

Amend: 6004.3.1.1 Quantities Not Exceeding the Maximum Allowable Quantity per Control Area. The outdoor storage or use of highly toxic and toxic gases in amounts exceeding the threshold quantity per control area set forth in Table 6004.3 shall be in accordance with Sections 5001, 5003, 6001, 6004.1, and 6004.3.

Moderately toxic gases with an LC₅₀ less than 3000 parts per million in amounts exceeding the threshold quantity in Table 6004.3 shall comply with the requirements for toxic gases in Sections 5001, 5003, 6001, 6004.1 and 6004.3.

Moderately toxic gases in amounts exceeding the threshold quantity in Table 6004.3 shall comply with the requirements for toxic gases in Sections 5001, 5003, 6001, 6004.1 and 6004.3.2.1 through 6004.3.2.5.

Amend: 6004.3.3 Outdoor Storage Weather Protection for Portable Tanks and Cylinders. Weather protection in accordance with Section 5004.13 and this Section shall be provided for portable tanks and cylinders located outdoors and not within gas cabinets or exhausted enclosures. The storage area shall be equipped with an approved automatic sprinkler system in accordance with Section 903.

Exception: Deleted

CHAPTER 80 - REFERENCED STANDARDS

The reference standards in Chapter 80 of the 2022 California Fire Code are amended as provided in this Section.

Amend: NFPA 13-16 is amended as follows:

Amend: 8.16.2.6.2 - Sprinkler drains shall discharge to the sanitary sewer, open planters having enough volume to contain the discharge, or bio swell approved by Building Services Department in accordance with OMC 13.16.

Amend: 8.17.2.4.6 - Fire department connection shall be located on each street of fire department access. When the fire department connection is located within 10 feet of the corner of a building adjacent to the fire department access, the fire department connection shall service both streets.

Amend: NFPA 13D-16 is amended as follows:

Amend: 6.2. Water Supply Sources. When approved by the Fire Code Official and the requirements are met, the following water supply sources shall be considered to be acceptable by this standard.

1. A connection to a reliable waterworks system with or without an automatically operated pump.
2. An elevated tank.
3. A pressure tank designed to American Society of Mechanical Engineers (ASME) standards for the pressure vessel with a reliable pressure source.
4. A stored water source with an automatically operated pump.
5. A well with a pump of sufficient capacity and pressure to meet the sprinkler system demand. The stored water requirement of 6.1.2 or 6.1.3 shall be permitted to be a combination of the water and the well (including the refill rate) plus the water in the holding tank if such tank can supply the sprinkler system.

Amend: 6.2.4 Where a water supply serves both domestic and fire sprinkler systems, 15 gpm shall be added to the sprinkler system demand at the point where the systems are connected, to determine the size of common piping and the size of the total water supply requirements where no provision is made to prevent flow into the domestic water system upon operation of a sprinkler.

Amend: Figure A.6.2 (a, b, or c) is amended as follows:

Sprinkler control valve and rubber-faced check valve is not permitted and shall be replaced with a listed double check valve assembly listed for fire-protection as required per adopted California Plumbing Code for backflow prevention devices.

Figure A.6.3 (a, b, or c) Multipurpose Piping System is not permitted.

8.6.4 - Deleted

Amend: NFPA 14-16 is amended as follows:

Amend: 6.3.7.1 System Water Supply valves, isolation control valves and other valves in fire mains shall be supervised in an approved manner in an open position by one of the following approved methods:

1. Where a building has a fire alarm system or a sprinkler monitoring system installed, the valve shall be supervised by:
 - (a) A central station, proprietary or remote supervising station.
 - (b) Deleted
2. Where a building does not have a fire alarm system or a sprinkler monitoring system installed, the valve shall be supervised by:
 - (a) Locking the valves in the open position or
 - (b) Sealing valves in an approved weekly recorded inspection where valves are located within fenced enclosures under the control of the owner.

(f) NFPA 24-16 is amended as follows:

Amend: 6.5.2.1 - Deleted

Add: 10.6.3.1.1 Only ductile iron shall be installed within 5 feet of a foundation or a wall.

(h) NFPA 72-16 is amended as follows:

Amend: 23.8.5.1.2 - Exception deleted

(j) SFM is amended by adding:

Add: SFM- State Fire Code Official- Solar Photovoltaic Installation Guideline

Add: NFPA 5000 Annex F is added as follows:

Amend: 510.5 Installation requirements. The installation of the public safety radio coverage system shall be in accordance with Sections 510.5.1 through 510.5.4 and Annex F of NFPA 5000 standard.

Add: 2020 NFPA 1932: Standard on the Use, Maintenance, Service Testing, of In-Service Fire Department Ground Ladders. 5.1.8.1, 5.1.8.2.

Add: 5.1.2.1: Where a property has slopes greater than 15% on grade and where the Emergency Escape and Rescue Openings (EERO) is required for R-3 occupancies fire crew access shall be provided to such properties with sloped access to all sleeping area openings with ground ladder access to the EERO for rescue. Properties subject to this requirement shall have:

1. On-site rise/run (7"/11") steps on grade or exterior stairs constructed by noncombustible material or heavy timber. 3-foot wide minimum steps on grade shall accommodate ground ladder movement along fire crew access paths to escape windows with a stable mountable platform/grade below rescue windows.
2. An All-weather pathway such as creosoted railway ties or equivalent shall be provided on the surface of stairs or ramps.

Add: 5.1.8.1.1: Setbacks shall be provided for ground mounting ladder to rescue openings per CFC 1030.

APPENDIX D - FIRE APPARATUS ACCESS STANDARDS

Appendix D Fire Apparatus Access Roads - is amended as follows:

Add: Appendix D 103.1.1 Fire Apparatus Access Standards

Figure 1. Local Standards and Shared Access Facilities Design Standards

Figure 2. Parking on Both Sides

Figure 3A. Parking on One Side (No Turnout)

Figure 3B. Parking on One Side (With Turnout)

Figure 4. No Parking on Both Sides (Private Streets Only)

Figure 5. Fire Hydrant Spacing Dead-End Road

Figure 6. Fire Hydrant Spacing Through Road

Figure 7. Hammerhead Turnaround

Figure 8. "Y" Turnaround

Figure 9. "L" Turnaround

Figure 10. Maximum Run on Varying Slopes

Figure 11. Maximum Slopes on Varying Runs

Section D103 - Minimum Specifications - *Figure D103.1 Dead-end Fire Apparatus Access Road Turnaround is amended as follows*

Amend: Table D103.4 Requirements for Dead-End Fire Apparatus Access Roads (Over 600 feet, Special approval required.)

1. AB SHALL BE LESS THAN 600'. OTHERWISE SECONDARY ACCESS IS REQUIRED.
2. AD SHALL BE LESS THAN 600'
3. IF $600' > AB \geq 300'$, THEN TURNOUT IS REQUIRED AT MIDPOINT.
4. $R \geq 35'$ IN WILDLAND-URBAN INTERFACE FIRE AREA. OTHERWISE, $R \geq 50'$.
5. S = SHARED ACCESS FACILITIES (SAF). IT SHALL BE 20 FEET MINIMUM.
6. IF $X+Y > 150$ FEET, MITIGATION REQUIRED.
7. SEE TABLE 1 FOR ADDITIONAL INFORMATION.
8. Z = DRIVEWAY WIDTH = 12' MIN IN WUI, OTHERWISE 10' MIN

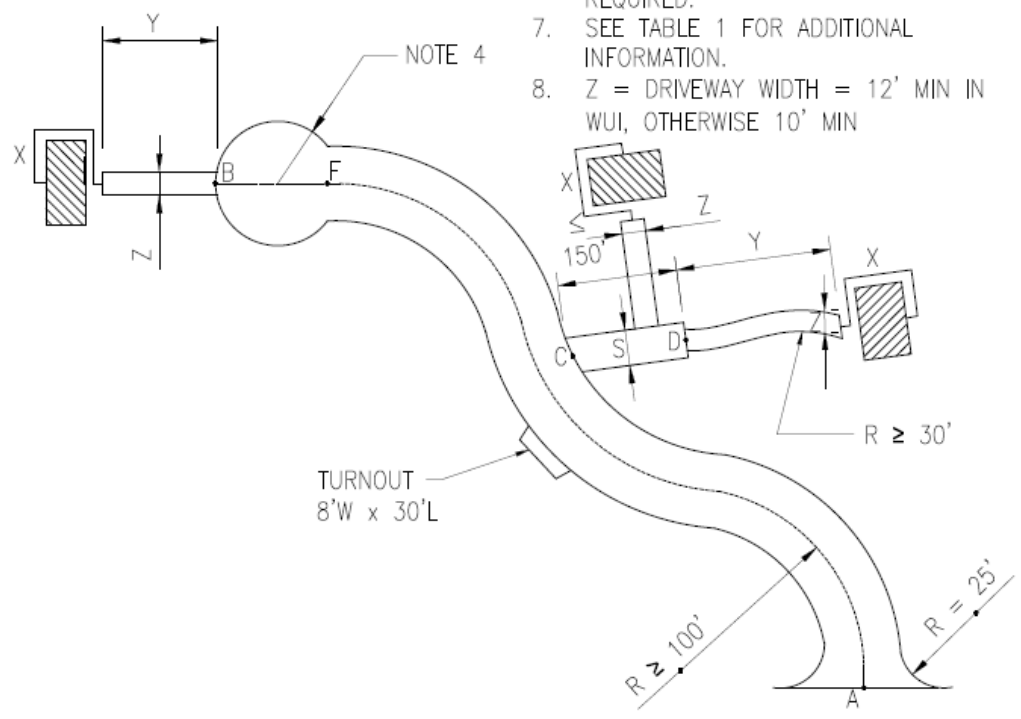

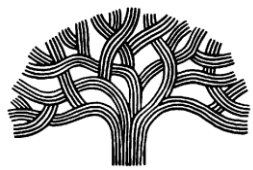
CITY OF OAKLAND		FIRE PREVENTION BUREAU	
	FIRE APPARATUS ACCESS STANDARDS		
	EMERGENCY VEHICLE ACCESS EASEMENT	DATE	FIGURE 1
	LOCAL STANDARDS AND SHARED ACCESS FACILITIES DESIGN STANDARDS	REV	

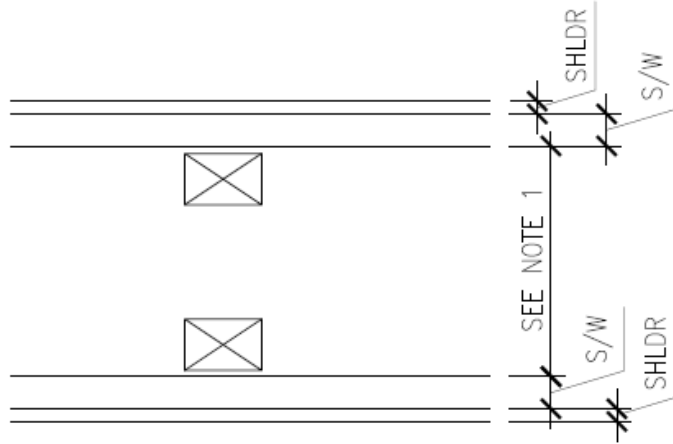

1. MIN ROADWAY CLEAR WIDTH = 36'
SERVING BUILDINGS UP TO 30'
AND ROADWAY CLEAR WIDTH = 42'
SERVING BUILDINGS MORE THAN
30' OR SERVED BY HYDRANTS
2. SEE CITY OF OAKLAND MUNICIPAL
CODE FOR SIDEWALK (S/W) AND
SHOULDER (SHLDR) REQUIREMENTS

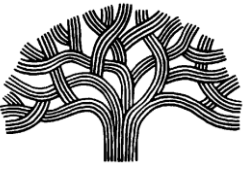
CITY OF OAKLAND	FIRE PREVENTION BUREAU		
	FIRE APPARATUS ACCESS STANDARDS		
	EMERGENCY VEHICLE ACCESS EASEMENT	DATE	FIGURE 2
	PARKING ON BOTH SIDES	REV	

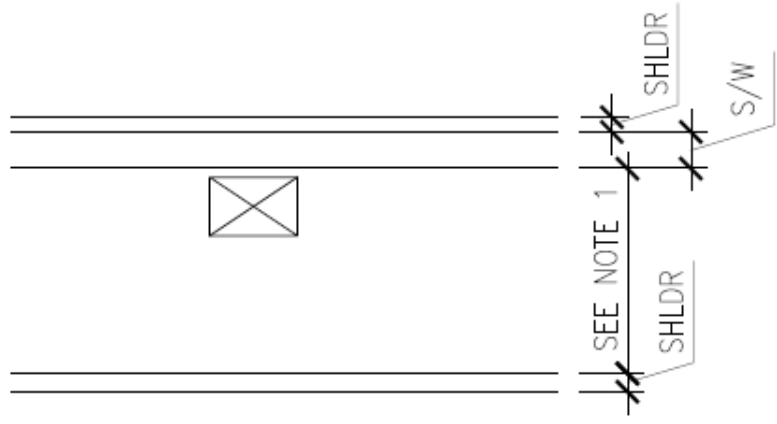

1. MIN ROADWAY WIDTH = 28'
SERVING BUILDINGS UP TO 30'
AND ROADWAY CLEAR WIDTH = 34'
SERVING BUILDINGS MORE THAN
30' OR SERVED BY HYDRANTS
2. SEE CITY OF OAKLAND MUNICIPAL
CODE FOR SIDEWALK (S/W) AND
SHOULDER (SHLDR) REQUIREMENTS

CITY OF OAKLAND	FIRE PREVENTION BUREAU		
[OBJ]	FIRE APPARATUS ACCESS STANDARDS		
	EMERGENCY VEHICLE ACCESS EASEMENT	DATE	FIGURE 3A
	PARKING ON ONE SIDE (NO TURNOUT)	REV	

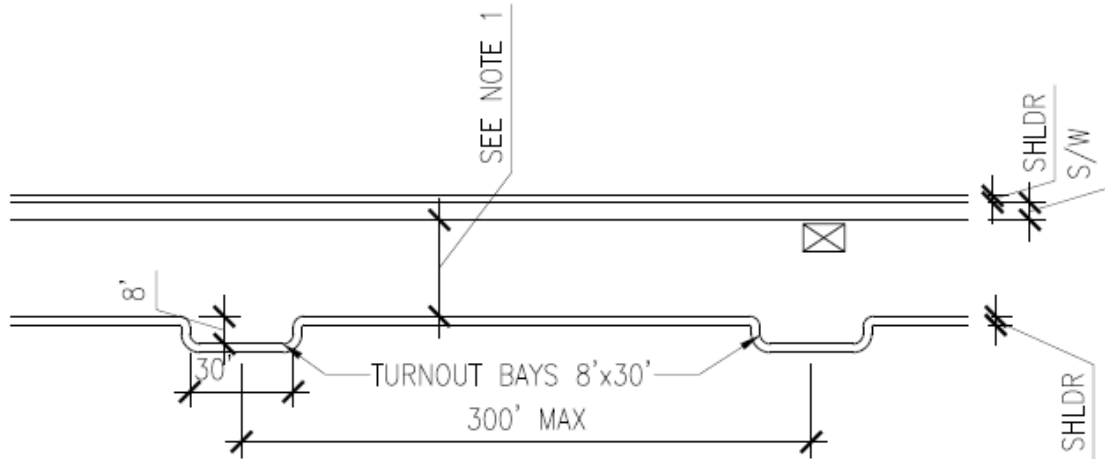

1. MIN ROADWAY WIDTH = 28' SERVING BUILDINGS UP TO 30' AND ROADWAY WIDTH = 36' SERVING BUILDINGS MORE THAN 30' OR SERVED BY HYDRANTS
2. SEE CITY OF OAKLAND MUNICIPAL CODE FOR SIDEWALK (S/W) AND SHOULDER (SHLDR) REQUIREMENTS

CITY OF OAKLAND	FIRE PREVENTION BUREAU		
	FIRE APPARATUS ACCESS STANDARDS		
	EMERGENCY VEHICLE ACCESS EASEMENT	DATE	FIGURE 3B
	PARKING ON ONE SIDE (WITH TURNOUT)	REV	

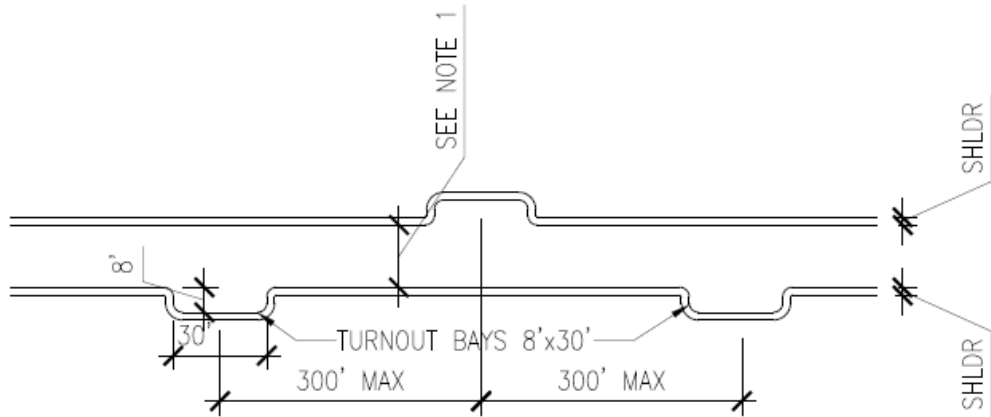

1. MIN ROADWAY WIDTH = 20' SERVING BUILDINGS UP TO 30' AND ROADWAY WIDTH = 26' SERVING BUILDINGS MORE THAN 30' OR SERVED BY HYDRANTS
2. SEE CITY OF OAKLAND MUNICIPAL CODE FOR SIDEWALK (S/W) AND SHOULDER (SHLDR) REQUIREMENTS

CITY OF OAKLAND	FIRE PREVENTION BUREAU		
	FIRE APPARATUS ACCESS STANDARDS		
	EMERGENCY VEHICLE ACCESS EASEMENT	DATE	FIGURE 4
	NO PARKING ON BOTH SIDES (PRIVATE STREETS ONLY)	REV	

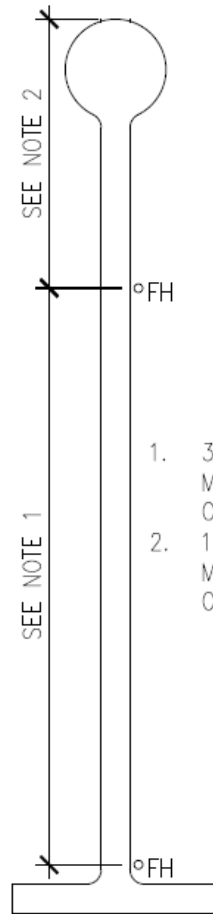

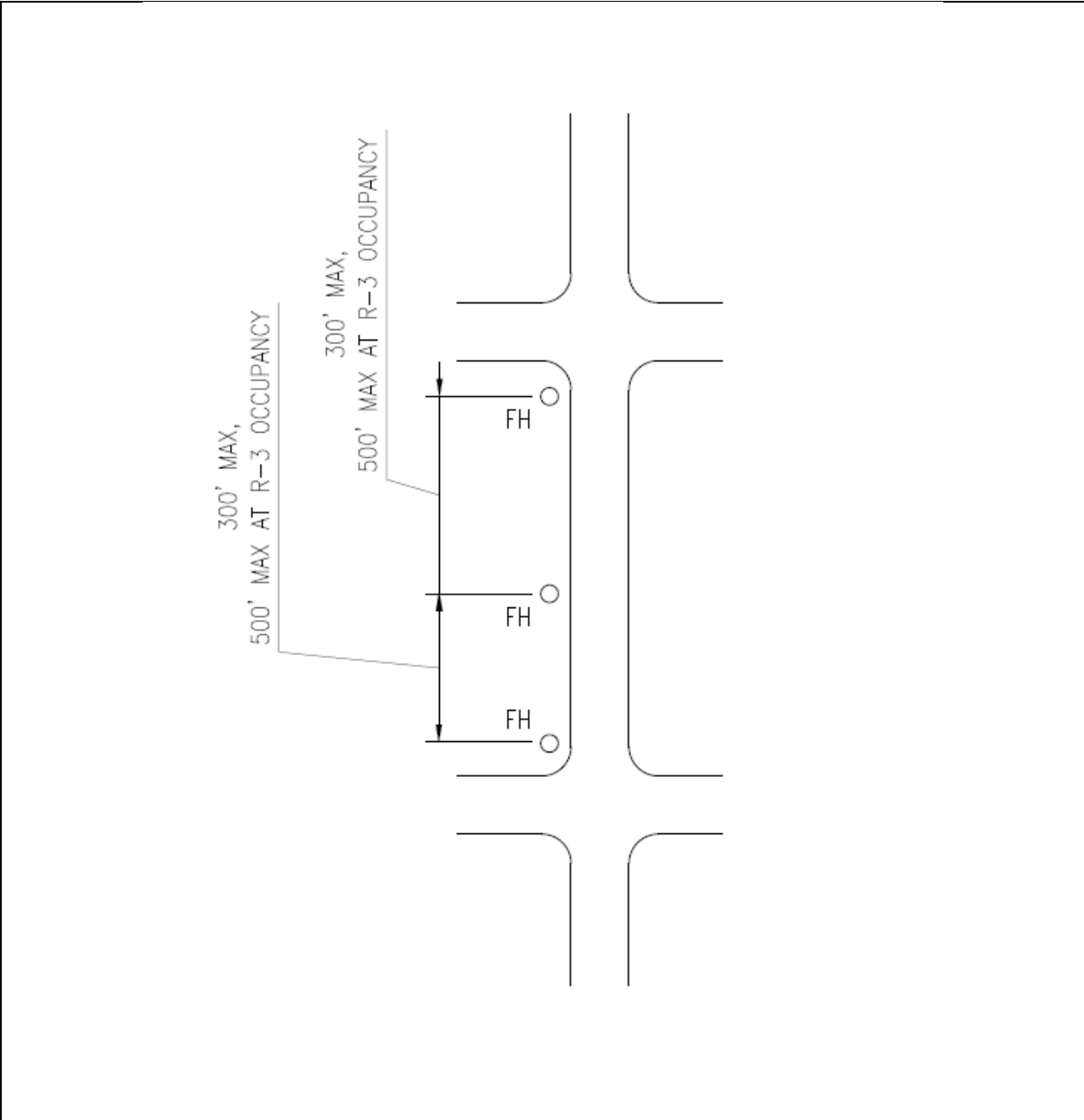

1. 300' MAX, 500'
MAX AT R-3
OCCUPANCY
2. 150' MAX, 250'
MAX AT R-3
OCCUPANCY

CITY OF OAKLAND	FIRE PREVENTION BUREAU		
	FIRE APPARATUS ACCESS STANDARDS		FIGURE 5
	EMERGENCY VEHICLE ACCESS EASEMENT	DATE	
	FIRE HYDRANT SPACING DEAD-END ROAD	REV	

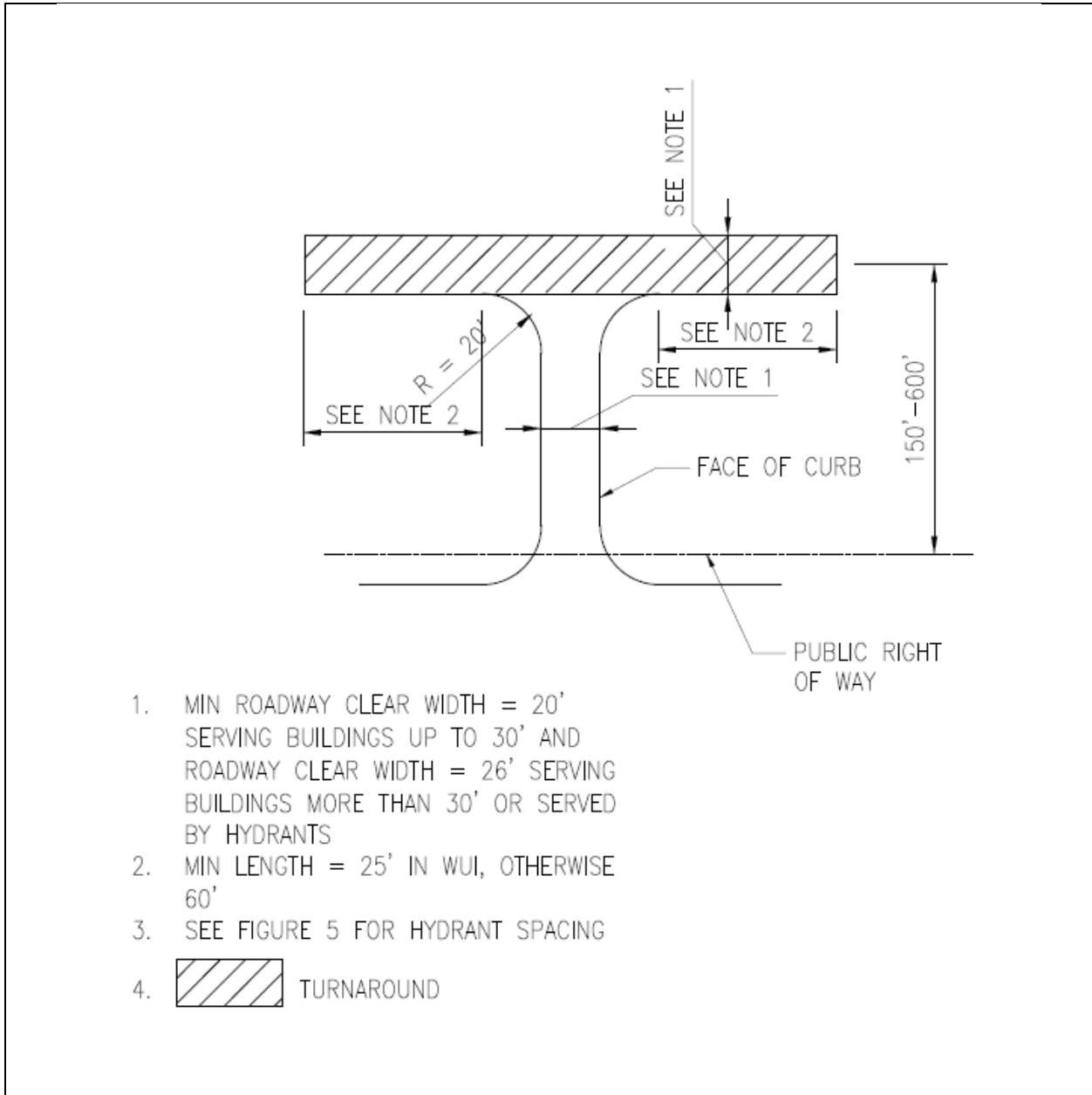

CITY OF OAKLAND	FIRE PREVENTION BUREAU		
	FIRE APPARATUS ACCESS STANDARDS		
	EMERGENCY VEHICLE ACCESS EASEMENT	DATE	FIGURE 6
	FIRE HYDRANT SPACING THROUGH ROAD	REV	



CITY OF OAKLAND	FIRE PREVENTION BUREAU		
	FIRE APPARATUS ACCESS STANDARDS		
	EMERGENCY VEHICLE ACCESS EASEMENT	DATE	FIGURE 7
	HAMMERHEAD TURNAROUND	REV	

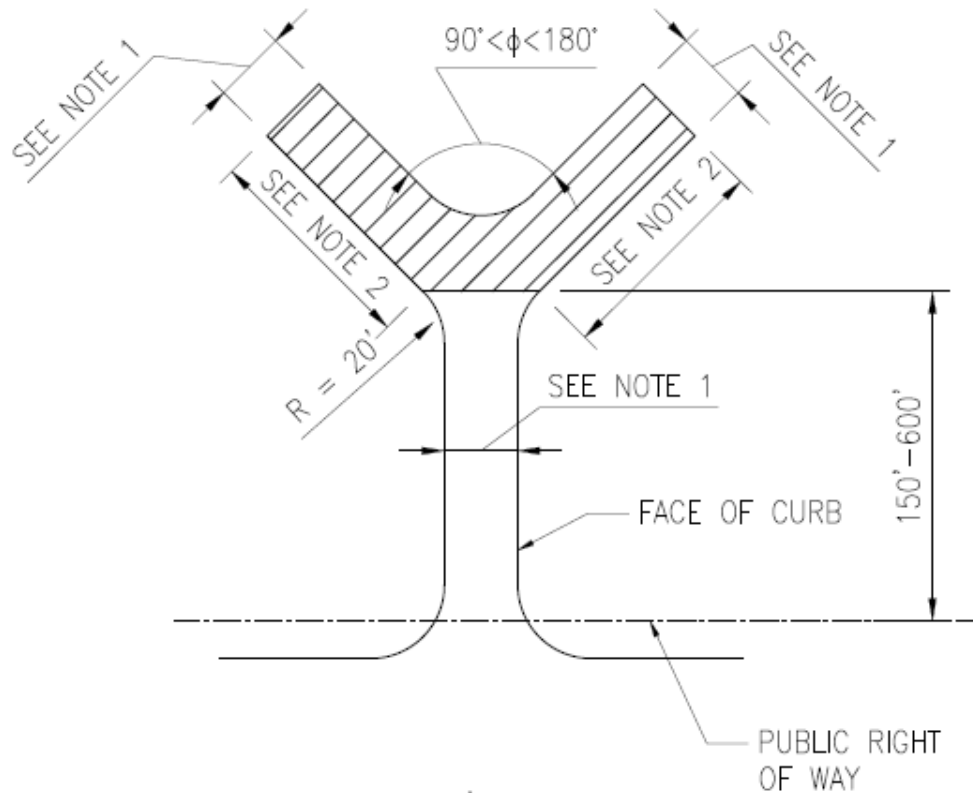

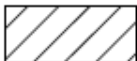

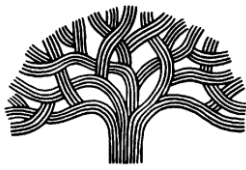
1. MIN ROADWAY CLEAR WIDTH = $20'$
SERVING BUILDINGS UP TO $30'$ AND
ROADWAY CLEAR WIDTH = $26'$ SERVING
BUILDINGS MORE THAN $30'$ OR SERVED
BY HYDRANTS
2. MIN LENGTH = $25'$ IN WUI, OTHERWISE
 $60'$
3. SEE FIGURE 5 FOR HYDRANT SPACING
4.  TURNAROUND

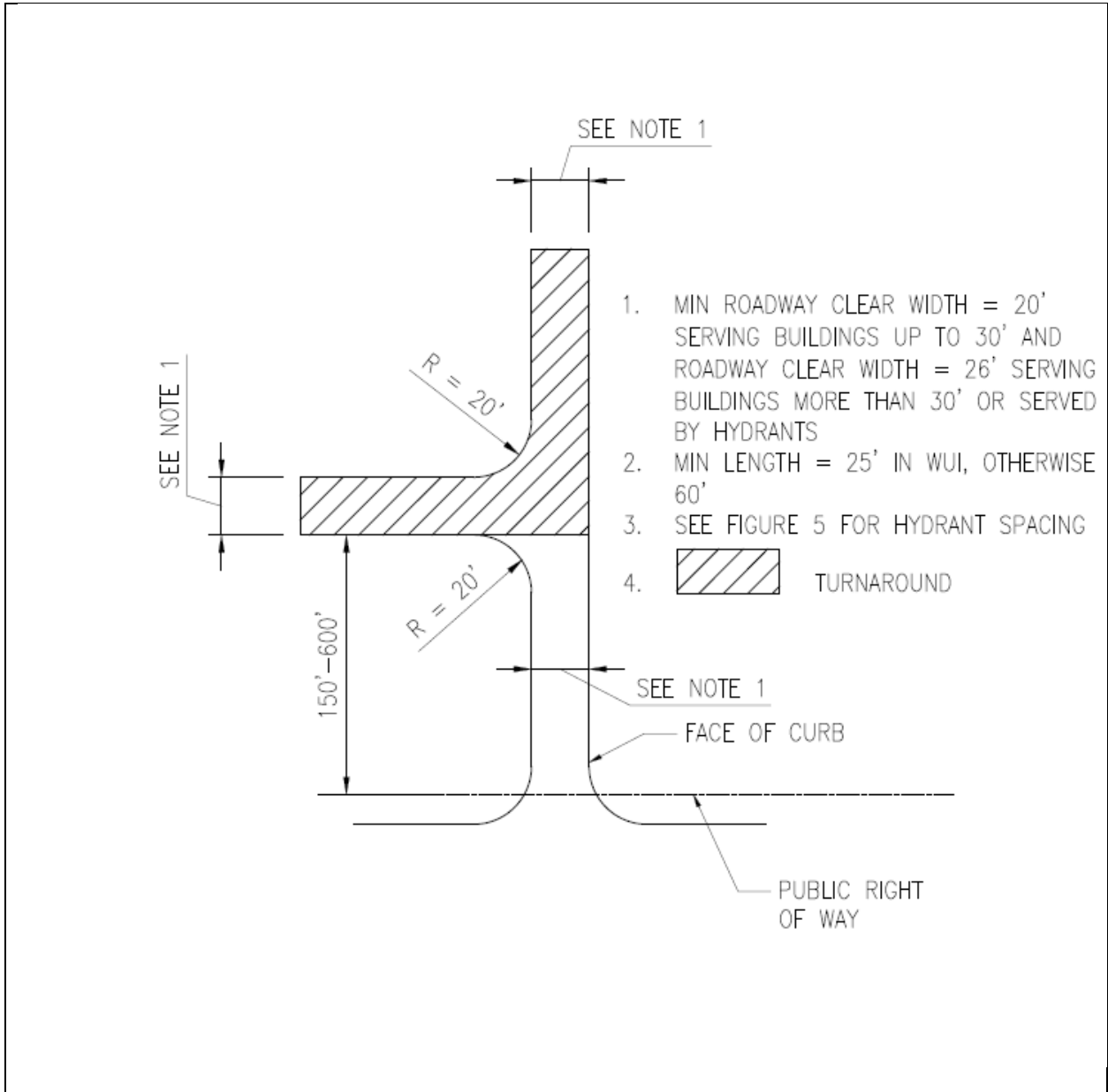
CITY OF OAKLAND		FIRE PREVENTION BUREAU	
	FIRE APPARATUS ACCESS STANDARDS		
	EMERGENCY VEHICLE ACCESS EASEMENT	DATE	FIGURE 8
	"Y" TURNAROUND	REV	

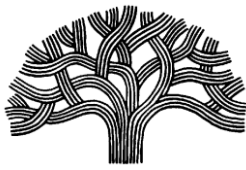

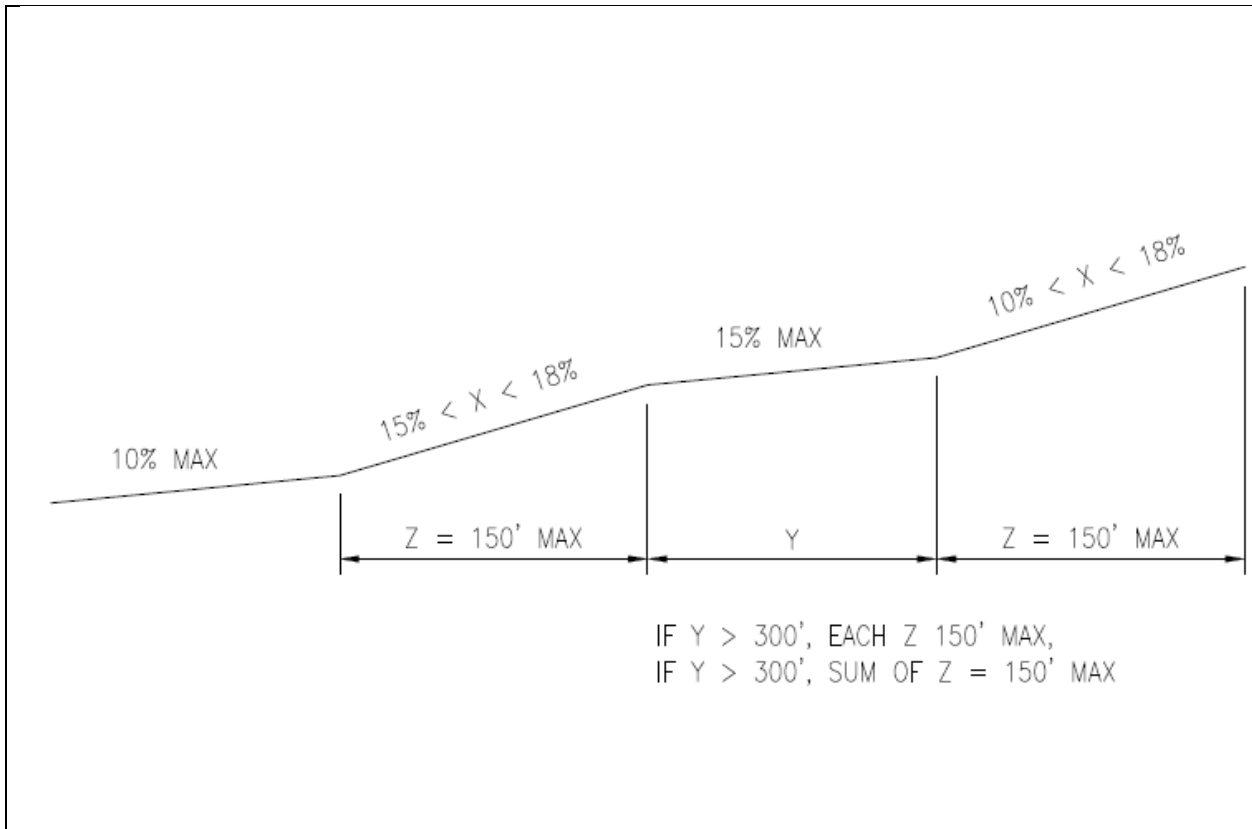
CITY OF OAKLAND	FIRE PREVENTION BUREAU		
	FIRE APPARATUS ACCESS STANDARDS		
	EMERGENCY VEHICLE ACCESS EASEMENT	DATE	FIGURE 9
	"L" TURNAROUND	REV	



CITY OF OAKLAND	FIRE PREVENTION BUREAU		
	FIRE APPARATUS ACCESS STANDARDS		
	EMERGENCY VEHICLE ACCESS EASEMENT	DATE	FIGURE 10
	MAXIMUM RUN ON VARYING SLOPES	REV	

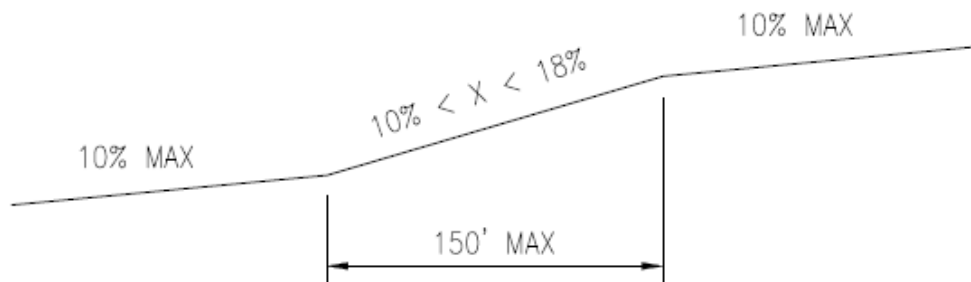

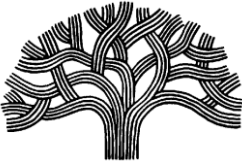
CITY OF OAKLAND	FIRE PREVENTION BUREAU		
	FIRE APPARATUS ACCESS STANDARDS		
	EMERGENCY VEHICLE ACCESS EASEMENT	DATE	FIGURE 11
	MAXIMUM SLOPES ON VARYING RUNS	REV	

Add: Table D103.5. Design Requirements for Local Streets and Shared Access Facilities (SAF)

	Local Public and Private Streets (A)	Shared Access Facilities (SAF) (B)	Street + SAF (C)	Secondary Access Required (D)
1. Length (for dead-end streets)	< 600 ft (AB in Fig. 1) If > 600 ft. mitigation, reqd. (see item 10a)	≤ 150 ft (CD in Fig. 1) If > 150 ft, mitigation. reqd. (see item 10a)	< 600 ft (AD in Fig. 1) If > 600 ft, mitigation. reqd. (see item 10a)	Street > 600 ft SAF > 600 ft Street + SAF > 600 ft Loop roads and streets with dead-end fingers shall be evaluated on a case by case basis.
2. Width	See Figure 2, 3A, 3B	≥ 20 Ft clear for SAF length > 150 ft	-	Minimum 20 ft clear
3. Road Radius	> 100 ft to centerline of street	≥ 30 ft to inner curve	-	Minimum 30 ft to inner curve
4. Curb Radius	25 ft	20 ft	-	20 ft
5. Turnaround (35 ft radius, hammer-head, "Y" or "L") Design Criteria: WUI-fire engine flatlands-fire truck or fire engine	> 150 ft street length circular (if there are no R/W restrictions) hammerhead optional (if R/W restrictions exist)	> 150 ft SAF length a. circular b. hammerhead c. "Y" d. "L" Items a, b, c, & d at applicant's option	> 150 ft total length (turnaround either on street or PAE) Same as SAF for turnaround in SAF. Same as street for turnaround in street	N/A
6. Access length to buildings (x+y in Fig. 1)	≤ 150 ft. If > 150 ft, mitigation. reqd. (see item 10b)	≤ 150 ft If > 150 ft, mitigation. reqd. (see item 10b)	N/A	N/A
7. Turnouts (8 ft W x 30 ft L)	When required, see Figure 1, 3B	Same as public and private streets	Same as public and private streets	Required 300 ft on center max., staggered both sides
8. Retaining Walls	8 ft max. wall ht. Within private R/W	8 ft max. wall ht. If ht. > 5 ft, use	See Columns (A) & (B)	Same as SAF

	Local Public and Private Streets (A)	Shared Access Facilities (SAF) (B)	Street + SAF (C)	Secondary Access Required (D)
	can be combustible to 3 ft. Within public R/W must be noncombustible	noncombustible materials. Walls < 5 ft. can be heavy timber construction per UBC		
9. Road Grades	Slope ≤ 10% (unlimited length) 10% - 18% slope up to 150 ft. If 10% - 18% slope > 150 ft then mitigation. Required (see item 10c) or response time ≤ 4 minutes must be demonstrated.	10% - 18% slope up to 300 ft max. If 300-600 ft., then mitigation. required (see item 10c)	N/A	10%-18% for 300 ft. max. If < 10%, then no length limit (see item 10C for required road surface)
		< 10% slope, 300-600 ft length.		
10. Mitigation measures a. Length to end of road	If > 600 ft., then secondary access/egress required.	If 300-600 ft. length, then 20 ft width; turnaround; hydrant required.	If > 600 ft., then secondary access required.	If a secondary access in required, 600 ft. max. distance from any parcel to through street shall be provided (see Fig. 10)
		If 150-300 ft. length, then fire sprinkler; fire resistive constr. *; vegetation mgmt. *; hydrant required (*these are available as mitigations only when area is outside of Wildfire Prevention Assessment District — WPAD)		
b. Length to the farthest part of the building.	If > 150 ft. from street, then enhanced fire sprinkler or 20 ft. width + turnaround + hydrant required.	20 ft. width + turnaround + hydrant required.	N/A	N/A

	Local Public and Private Streets (A)	Shared Access Facilities (SAF) (B)	Street + SAF (C)	Secondary Access Required (D)
c. Road grade	AMR is required. Enhanced fire sprinkler and additional hydrant (spacing per Fire Code Official)	AMR is required. Enhanced fire sprinkler and additional hydrant (spacing per Fire Code Official)	AMR is required. Enhanced fire sprinkler and additional hydrant (spacing per Fire Code Official)	If < 10%, then all-weather surface is required. If > 10%, then asphalt or concrete pavement is required.

3225277v1