



CITY OF OAKLAND

FILED
OFFICE OF THE CITY CLERK
OAKLAND

2016 MAR 10 PM 12:40

AGENDA REPORT

TO: Sabrina B. Landreth
City Administrator

FROM: Brooke A. Levin
Director, Public Works

SUBJECT: Major Encroachment Permit at
1955 Broadway , 459 8th Street, 4435
Piedmont Avenue, 459 23rd Street,
5239 Claremont Avenue

DATE: February 11, 2016

City Administrator Approval

Date:

3/9/16

RECOMMENDATION

Staff Recommends That The City Council Adopt Five Resolutions Approving Major Encroachment Permits Associated With Architectural Building Elements That Encroach Into The Public Right-Of-Way.

1. **Resolution Granting A Conditional And Revocable Major Encroachment Permit To Zwuschen, LLC To Allow Portion Of The Existing Building At 1945 And 1955 Broadway To Encroach Into The Public Right-Of-Way Along The Building Frontage On Broadway And On 20th Street, Major Encroachment Permit ENMJ15057.**
2. **Resolution Granting A Conditional And Revocable Major Encroachment Permits To Broadway Oak Partners LLC To Allow Portion Of The Building Above Grade At 459 8th Street To Encroach Into The Public Right-Of-Way Along 8th Street And Broadway, Major Encroachment Permit ENMJ16001.**
3. **Resolution Granting A Conditional And Revocable Major Encroachment Permits To Trustees Chapel Of The Chimes Special Care Funds To Allow Portion Of The Building Above Grade At 4435 Piedmont Avenue To Encroach Into The Public Right-Of-Way Along The Building Frontage On Piedmont Avenue, Major Encroachment Permit ENMJ15060.**
4. **Resolution Granting A Conditional And Revocable Major Encroachment Permits To 265 Vernon Street, LLC To Allow Portion Of The Building Above Sidewalk At 459 23rd Street To Encroach Into The Public Right-Of-Way Along The Building Frontage On 23rd Street And Valley Street, Major Encroachment Permit ENMJ16003.**
5. **Resolution Granting A Conditional And Revocable Major Encroachment Permits To Temescal Investors, LLC To Allow Portion Of The Building Above Grade At 5239 Claremont Avenue To Encroach Into The Public Right-Of-Way Along The Building Frontage On Telegraph Avenue, Major Encroachment Permit ENMJ16002.**

Item: _____
Public Works Committee
March 22, 2016

EXECUTIVE SUMMARY

The resolutions will authorize the City Engineer to issue Major Encroachment Permits to allow various architectural elements of existing and planned buildings to encroach into the public right-of-way at several locations: 1955 Broadway, 459 8th Street, 4435 Piedmont Avenue, 459 23rd Street, and 5239 Claremont Avenue.

The encroachment permits will require the property owner to comply with the conditions of approval issued previously by the City Planning and Building Department.

These encroachments are described in more detail in Exhibits to each Resolution. They are for architectural elements that encroach into the public right-of-way above the sidewalk. The encroachments do not impact the use of the sidewalk fronting the property nor do they obstruct the path of travel for pedestrians or persons with disabilities.

BACKGROUND / LEGISLATIVE HISTORY

The Oakland Municipal Code (OMC) requires a major encroachment permit be issued for any building element or other private improvement that encroaches into the public right-of-way.

1945 - 1955 Broadway: The Planning Department and Landmarks Advisory Board have both approved plans for the building façade that include elements that encroach into the existing public right-of-way. Zwuschen, LLC has applied for conditional and revocable Major Encroachment Permit (ENMJ15057) to allow a portion of the building at 1945 and 1955 Broadway to encroach into the public right-of-way along the building frontage on Broadway and on 20th Street. These encroachments include new window openings that comply with requirements placed on the project by the City's Landmarks Preservation Advisory Board and Planning Department.

The permit will also address existing encroachments including: a) building basement under the sidewalk to back of curb along Broadway, 20th Street, and Telegraph Avenue; b) wall of the building that encroaches 0.71 feet into the sidewalk on Broadway; c) a roof parapet architectural element (roof overhang) that extends 5.50 feet on Broadway and 0.70 feet on 20th Street, and 0.70 feet on Telegraph Avenue; d) a main entrance awning that extends 8.00 feet into right of way space on Broadway; and e) a retail entrance that extends 2.70 feet into right of way space of Broadway. All of these encroachments are between 12 and 19 feet above the sidewalk.

Proposed encroachments for installation of the exterior building façade required by the City Planning Department, will add 0.76 feet to the face of the building on Broadway along the sidewalk to roof overhang.

459 8th Street: The Planning Department had approved the development (permit number: PLN14-308) as a five story building with encroachment into right of way space for fifty dwelling units with commercial space at ground floor. The encroachment permit (ENMJ16001) proposed to be issued to Broadway Oak Partners LLC allows for covered balconies above ground from second floor to roof, 16.0 feet above the sidewalk and 4.0 feet into the right of way space. This

encroachment will have no impact on the path of travel for pedestrians or persons with disabilities.

4435 Piedmont Avenue: The Planning Department had approved the development (permit number: PLN14296) as a three story building with encroachment into right of way space for twenty five dwelling units with commercial space at ground floor. The encroachment permit (ENMJ15060) proposed to be issued to Chapel Of The Chimes Special Care Funds allows for covered balconies above ground from second floor to roof, beginning 12.0 feet above the sidewalk and encroaching 4.0 feet into the right of way space

459 23rd Street: The Planning Department had approved the development (permit number: PLN15119) as a five story building with encroachment into right of way space for sixty five unit residential building with commercial space at ground floor. The encroachment permit (ENMJ16003) proposed to be issued to Vernon Street, LLC allows for covered and open balconies above ground from second floor to roof, 16.0 feet above the sidewalk and 5.0 feet into the right of way space

5239 Claremont Avenue: The Planning Department had approved the development (permit number: PLN 15119) as a five story building with encroachment into the right of way space for thirty three unit residential building with commercial space at ground floor. The encroachment permit (ENMJ16002) proposed to be issued to Temescal Investors, LLC allows for bay windows, 22.79' above the sidewalk on 3rd and 4th floors to encroach 1.04 feet in the into the right of way space

None of the proposed permitted encroachments will have an impact on the path of travel for pedestrians or persons with disabilities, and all are in compliance with conditions of approval and building plans approved by the Planning and Building Department.

ANALYSIS AND POLICY ALTERNATIVES

The proposed encroachments will not interfere with public use of the right-of-way or buried utilities and will not endanger the public welfare and convenience. These encroachments are existing conditions or are proposed improvements approved by the Planning and Building Department.

Approval of these Major Encroachment permits will allow the City to execute an indenture agreement with the property owners holding the property owners liable and responsible for private improvements constructed in the public right-of-way and will allow for construction and maintenance of the encroachments. The indenture agreement will also allow the City to revoke the Permit when necessary and require the property owner to remove the encroachment and restore the public right of way if necessary.

FISCAL IMPACT

There is no fiscal impact on the City as the result of these Major Encroachment permits. Staff costs for processing the proposed encroachment permit is covered by fees set by the Master Fee Schedule and have been paid by the property owner.

PUBLIC OUTREACH / INTEREST

These items do not require special public outreach other than the required posting on the City's website.

COORDINATION

This Major Encroachment permits were coordinated with Planning and Building Department, and reviewed by the Budget Office and Office of the City Attorney.

SUSTAINABLE OPPORTUNITIES

Economic - These Major Encroachment permits will allow developers to meet the Planning Department's approval for the improvements. The improvements will add a total of one hundred and seventy three residential units in Oakland which would ultimately increase revenues through increased sales and property taxes.

Environmental – There is no identifiable environmental benefit to the City resulting from Major Encroachment permits.

Social Equity – There is no identifiable social equity benefit to the City resulting from these Major Encroachment permits.

CEQA

The California Environmental Quality Act ("CEQA") and the CEQA Guidelines exempt specific types of projects from environmental review. The following CEQA exemptions apply to this project, each of which provide a separate and independent basis for CEQA clearance: CEQA Guidelines sections 15301 (existing facilities), 15183 (projects consistent with a Community Plan, General Plan, or Zoning), and 15061(b)(3) (no significant effect on the environment).

ACTION REQUESTED OF THE CITY COUNCIL

Staff recommends that the City Council adopt Major Encroachment Permits through the following Resolutions:

1. Resolution granting a conditional and revocable major encroachment permit to Zwuschen, LLC to allow portion of the existing building at 1945 And 1955 Broadway to encroach into the public right-of-way along the building frontage on Broadway and On 20th Street, Major Encroachment Permit ENMJ15057.
2. Resolution granting a conditional and revocable major encroachment permits to Broadway Oak Partners LLC to allow portion of the building above grade at 459 8th

Street to encroach into the public right-of-way along 8th Street and Broadway, Major Encroachment Permit ENMJ16001.

3. Resolution granting a conditional and revocable major encroachment permits to Trustees Chapel of the Chimes Special Care Funds to allow portion of the building above grade at 4435 Piedmont Avenue to encroach into the public right-of-way along the building frontage on Piedmont Avenue, Major Encroachment Permit ENMJ15060.
4. Resolution granting a conditional and revocable major encroachment permits to 265 Vernon Street, LLC to allow portion of the building above sidewalk at 459 23rd Street to encroach into the public right-of-way along the building frontage on 23rd Street and Valley Street, Major Encroachment Permit ENMJ16003.
5. Resolution granting a conditional and revocable major encroachment permits to Temescal Investors, LLC to allow portion of the building above grade at 5239 Claremont Avenue to encroach into the public right-of-way along the building frontage on Telegraph Avenue, Major Encroachment Permit ENMJ16002.

For questions regarding this report, please contact Gus Amirzehni, Engineering Design and Right-of-Way Manager at (510) 238-6601.

Respectfully submitted,



Brooke A. Levin
Director, Oakland Public Works

Reviewed by:
Michael J. Neary, P.E., City Engineer
Bureau of Engineering and Construction

Reviewed by:
Gus Amirzehni, P.E., Division Manager
Engineering Design and R.O.W.

Prepared by:
Kevin Kashi, P.E., Supervising Civil Engineer
Engineering Design and R.O.W. Mgmt Division

Item: _____
Public Works Committee
March 22, 2016

2016 MAR 10 PM 12:40

RESOLUTION No. _____ C.M.S.

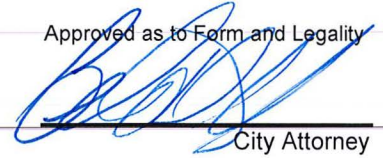

City Attorney

Introduced by Councilmember _____

RESOLUTION GRANTING A CONDITIONAL AND REVOCABLE MAJOR ENCROACHMENT PERMIT TO ZWUSCHEN, LLC TO ALLOW PORTION OF THE EXISTING BUILDING AT 1945 AND 1955 BROADWAY TO ENCROACH INTO THE PUBLIC RIGHT-OF-WAY ALONG THE BUILDING FRONTAGE ON BROADWAY AND ON 20TH STREET

WHEREAS, Zwuschen, LLC. ("Permittee"), the owner of the real property known as 1955 Broadway Street and described in a Grant Deed Recorded September 23, 2015 by the Alameda County Clerk-Recorder and identified by the Alameda County Assessor as APN: 008-0639-001 and commonly known as 1945 and 1955 Broadway hereto and incorporated herein, has filed an application with Public Works for a conditional and revocable permit (ENMJ 15057) to allow portions the existing building fronting Broadway and 20th Street to encroach into the public right-of-way;

WHEREAS, the limits of the encroachment are delineated in Attachment A hereto and Incorporated herein; and

WHEREAS, the City has issued conditional and revocable major encroachment permit for existing encroachments into the right of way when parcels are divided or merged creating new entities which must be made current with the Oakland Municipal Code; and

WHEREAS, staff has determined, based on review of the plans and investigation of the site of the encroachment, said encroachments in the public right-of-way and their location will not interfere with public use of the roadway, sidewalk, buried utilities, and will not endanger the public welfare and convenience during said public use; and

WHEREAS, each as a separate and independent basis, this action is exempt from the California Environmental Quality Act ("CEQA") pursuant to CEQA Guidelines sections 15301(existing facilities), 15183 (projects consistent with General Plan and Zoning), and 15061(b)(3) (no significant effect on the environment); now, therefore, be it

RESOLVED: That the City Council has reviewed all relevant documents relating to its grant of the encroachment permit that is the subject of this resolution; and be it

FURTHER RESOLVED: That the City Council finds and determines that the decision made hereby is made in conformance with the requirements of CEQA; and be it

FURTHER RESOLVED: That the City Council hereby grants to the Permittee a conditional revocable major encroachment permit to allow encroach into the public right-of-way and according to the permit conditions set forth below; and be it

FURTHER RESOLVED: That said major encroachment permit is hereby conditioned by the following special requirements:

1. This agreement may be voided and the associated permit for encroachments may be revoked at any time and for any reason, at the sole discretion of the City Council, expressed by resolution as being in the City's best interest, or the associated permit may be suspended at any time, at the sole discretion of the City Engineer, upon failure of the Permittee to comply fully and continuously with each and all of the conditions set forth herein and in the associated permit.
2. The Permittee hereby disclaims any right, title, or interest in or to any portion of the public right of way, including the sidewalk and street, and agrees that the encroachment is granted for an indeterminate period of time and that the use and occupancy by the Permittee of the public right of way is temporary and does not constitute an abandonment, whether expressed or implied, by the City of Oakland of any of its rights associated with the statutory and customary purpose and use of and operations in the public right-of-way.
3. The Permittee shall maintain fully in force and effect, at its own expense, at all times during the period for which the permit is in effect, good and sufficient public liability insurance in a face amount not less than \$300,000.00 for each occurrence, and property damage insurance in a face amount not less than \$50,000.00 for each occurrence, both including contractual liability, insuring the City of Oakland, its officers, agents, employees, and volunteers against any and all claims arising out of the existence of the encroachment in the public right-of-way, as respects liabilities assumed under this permit. The policy shall contain an endorsement declaring the policy as primary coverage on said liabilities. The Permittee shall submit a written certificate of such insurance or copy of the policy to City Engineer showing that insurance is in effect in compliance with this section, and shall file subsequent notices of the renewal thereof with the City Engineer. Such certificate shall state that the insurance coverage shall not be canceled, amended or be permitted to lapse without thirty (30) days' prior written notice to City Engineer. The Permittee also agrees that the City Engineer, at his or her sole discretion, may review the type and amount of insurance required of the Permittee annually and may require the Permittee to increase the amount of and/or change the type of insurance coverage required as circumstances warrant.
4. The Permittee shall be solely and fully liable and responsible for the repair, replacement, removal, reconstruction, and maintenance of any portion or all of the private improvements constructed or installed in the public right-of-way, whether by cause, neglect, or negligence of the Permittee or others, and for the associated costs and expenses necessary to restore or remove the encroachment to the satisfaction of the City Engineer, and shall not allow the encroachment to become a blight or a menace or a hazard to the health and safety of the general public.
5. The Permittee acknowledges and agrees that the encroachment is out of the ordinary and does not comply with City of Oakland standard installations. The Permittee further acknowledges and agrees that the City of Oakland and public utility agencies will

periodically conduct work in the public right-of-way, including excavation, trenching, and relocation of its facilities, all of which may damage the encroachment. The Permittee further acknowledges and agrees that the City and public utility agencies take no responsibility for ~~repair or replacement of the encroachment which may be damaged by the City or its~~ contractors or public utility agencies or their contractors. The Permittee further acknowledges and agrees that upon notification by and to the satisfaction of the City Engineer, Permittee shall immediately repair, replace, or remove, at the sole expense of the Permittee, all damages to the encroachment that are directly or indirectly attributable to work by the City or its contractors or public utility agencies or their contractors.

6. The Permittee shall remain liable for and shall immediately reimburse the City of Oakland for all costs, fee assessments, penalties, and accruing interest associated with the City's notification and subsequent abatement action for required maintenance, repairs, or removal, whether in whole or in part, of the encroachment or of damaged City infrastructure made necessary by the failure, whether direct or indirect, of the Permittee to monitor the encroachment effectively and accomplish preventative, remedial, or restorative work expeditiously. The City reserves the unqualified right to collect all monies unpaid through any combination of available statutory remedies, including recordation of Prospective Liens and Priority Liens/ Special Assessments with the Alameda County Recorder, inclusion of non-reimbursed amounts by the Alameda County Assessor with the annual assessment of the general levy, and awards of judgments by a court of competent jurisdiction.
7. Upon revocation of the encroachment permit, the Permittee shall immediately, completely, and permanently remove the encroachment from the public right-of-way, repair any damage resulting therefrom, and restore the public right-of-way to its original conditions existing before the construction or installation of the encroachment, to the satisfaction of the City Engineer and all at the sole expense of the Permittee.
8. This agreement and the associated permit for an encroachment shall become effective upon filing of this agreement with the Alameda County Recorder for recordation as an encumbrance of the property and its title.
9. The Permittee acknowledges that the City makes no representations or warranties as to the conditions beneath said encroachment. By accepting this revocable permit, Permittee agrees that it will use the encroachment area at its own risk, is responsible for the proper coordination of its activities with all other permittees, underground utilities, contractors, or workmen operating, within the encroachment area and for the safety of itself and any of its personnel in connection with its entry under this revocable permit.
10. The Permittee acknowledges that the City is unaware of the existence of any hazardous substances in encroachment area, and Permittee hereby waives and fully releases and forever discharges the City and its officers, directors, employees, agents, servants, representatives, assigns and successors from any and all claims, demands, liabilities, damages, actions, causes of action, penalties, fines, liens, judgments, costs, or expenses whatsoever (including, without limitation, attorneys' fees and costs), whether direct or indirect, known or unknown, foreseen or unforeseen, that may arise out of or in any way connected with the physical condition or required remediation of the excavation area of any law or regulation applicable thereto, including, without limitation, the Comprehensive Environmental Response, Compensation and Liability Act of 1980, as amended (42 U.S.C. Sections 9601 et seq.), the Resource Conservation and Recovery Act of 1976 (42 U.S.C. Section 466 et seq.), the Safe Drinking

Water Act (14 U.S.C. Sections 1401,1450), the Hazardous Waste Control Law (California Health and Safety Code Sections 25100 et seq.), the Porter-Cologne Water Quality Control Act (California Health and Safety Code Section 13000 et seq.), the Hazardous Substance Account Act (California Health and Safety Code Sections 253000 et seq.), and the Safe Drinking Water and Toxic Enforcement Act (California Health and Safety Code Section 25249.5 et seq.).

11. The Permittee further acknowledges that it understands and agrees that it hereby expressly waives all rights and benefits which it now has or in the future may have, under and by virtue of the terms of California Civil Code Section 1542, which reads as follows: "A GENERAL RELEASE DOES NOT EXTEND TO CLAIMS WHICH THE CREDITOR DOES NOT KNOW OR SUSPECT TO EXIST IN HIS FAVOR AT THE TIME OF EXECUTING THE RELEASE, WHICH IF KNOWN BY HIM MUST HAVE MATERIALLY AFFECTED HIS SETTLEMENT WITH THE DEBTOR." The Permittee recognizes that by waiving the provisions of this section. Permittee will not be able to make any claims for damages that may exist, and to which, if known, would materially affect its decision to agree to these encroachment terms and conditions, regardless of whether Permittee's lack of knowledge is the result of ignorance, oversight, error, negligence, or any other cause.
12. The Permittee shall, and by the acceptance of this revocable permit agrees and promises:
 - a. to indemnify, defend, save and hold harmless the City of Oakland, its officers, agents, employees, and volunteers, to the maximum extent permitted by law, from any and all suits, claims, demands, liabilities, damages, actions, causes of action, penalties, fines, liens, judgments, costs, or expenses whatsoever (including, without limitation, attorneys' fees and costs) (collectively referred to as "claims"), whether direct or indirect, known or unknown, foreseen or unforeseen, brought by any person for or on account of any bodily injuries, disease or illness or damage to persons and/or property sustained or arising in the construction of the work performed under the permit or arising out of the Permittee's failure to perform the obligations with respect to the use and occupancy of the public right-of-way by virtue of the permit, to the extent that such claims were either (1) caused by the Permittee, its agents, employees, contractors or representatives, or (2) in the case of environmental contamination, the claim is a result of environmental contamination that emanates or emanated from 1945, 1955 Broadway, Oakland, California site, or was otherwise caused by the Permittee, its agents, employees, contractors or representatives; and
 - b. if any contamination is discovered below or in the immediate vicinity of the encroachment, and the contaminants found are of the type used, housed, stored, processed or sold on the property, such shall amount to a rebuttable presumption that the contamination below, or in the immediate vicinity of, the encroachment was caused by the Permittee, its agents, employees, contractors or representatives; and
 - c. Permittee shall comply with all applicable federal, state, county and local laws, rules, and regulations governing the installation, maintenance, operation and abatement of the encroachment.
13. The encroachment permit and accompanying indenture agreement shall take effect when all the conditions hereinabove set forth shall have been complied with to the satisfaction of the City Engineer, and shall become null and void upon the failure of the Permittee to comply with all conditions.

14. The Indenture Agreement alone does not allow work to be done which requires permitting and/or inspection, and the Permittee shall obtain any and all required permits before beginning work.

15. The hereinabove conditions shall be binding upon the Permittee and the successive owners and assigns thereof; and be it

FURTHER RESOLVED: That the City Council, at its sole discretion and at a future date not yet determined, may impose additional and continuing fees as prescribed in the Master Fee Schedule, for use and occupancy of the public right-of-way; and be it

FURTHER RESOLVED: That this resolution shall take effect when all the conditions hereinabove set forth shall have been complied with to the satisfaction of the City Attorney and the City Engineer of the City of Oakland and shall become null and void upon the failure of the Permittee to comply with the conditions hereinabove set forth after notice and failure to cure such conditions in a reasonable manner; and be it

FURTHER RESOLVED: That the City Engineer is hereby directed to file a certified copy of this resolution for recordation with the Office of the Alameda County Clerk-Recorder as an encumbrance of the title of the property identified above.

IN COUNCIL, OAKLAND, CALIFORNIA, _____, 20_____

PASSED BY THE FOLLOWING VOTE:

AYES - BROOKS, CAMPBELL WASHINGTON, GALLO, GUILLEN, KALB, KAPLAN, REID, and
PRESIDENT GIBSON MCELHANEY

NOES -

ABSENT -

ABSTENTION -

ATTEST: _____

LaTonda Simmons
City Clerk and Clerk of the Council
of the City of Oakland, California

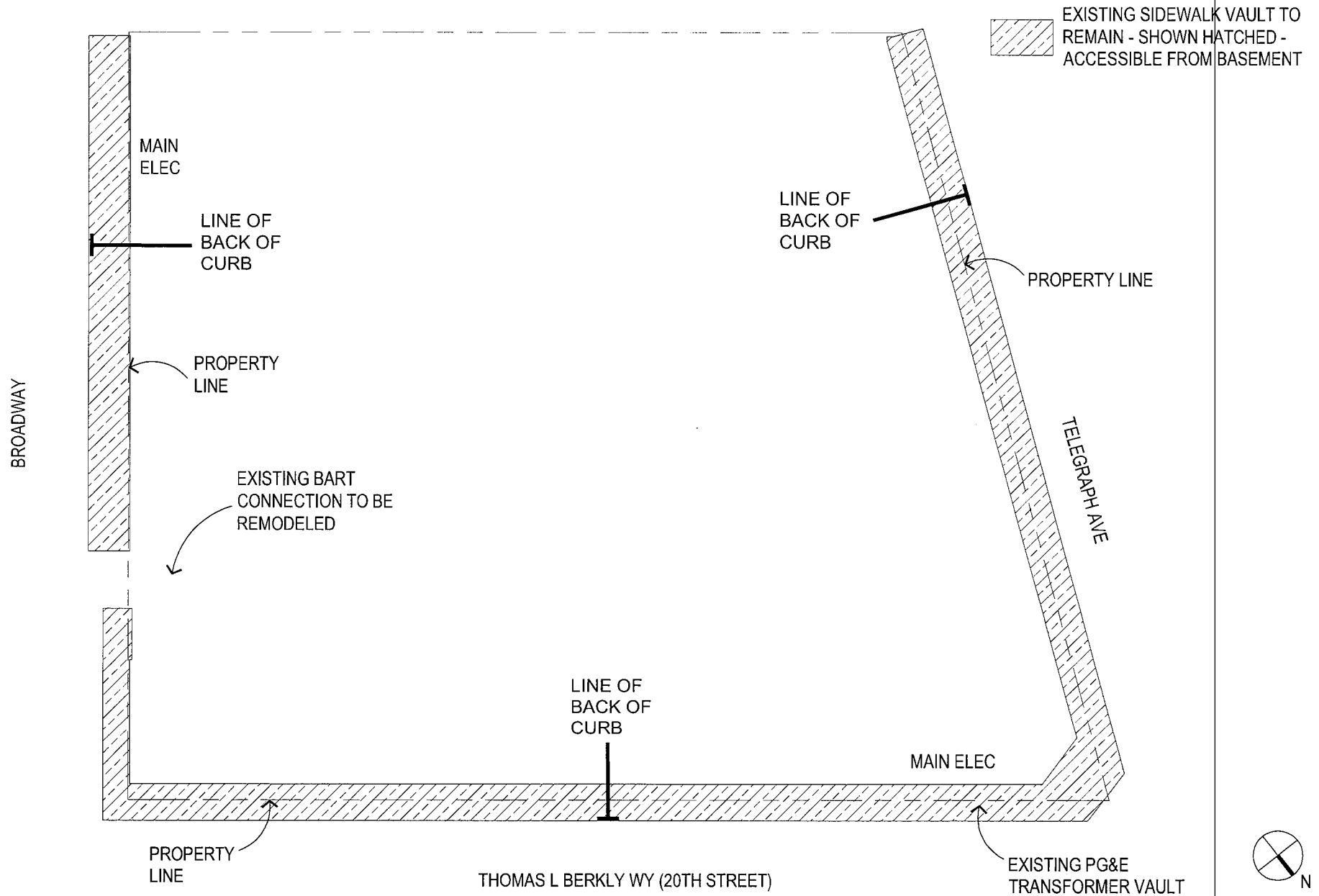

ENCROACHMENT PERMIT DIAGRAMS - BASEMENT PLAN

UPTOWN STATION



SK-1

01/22/16

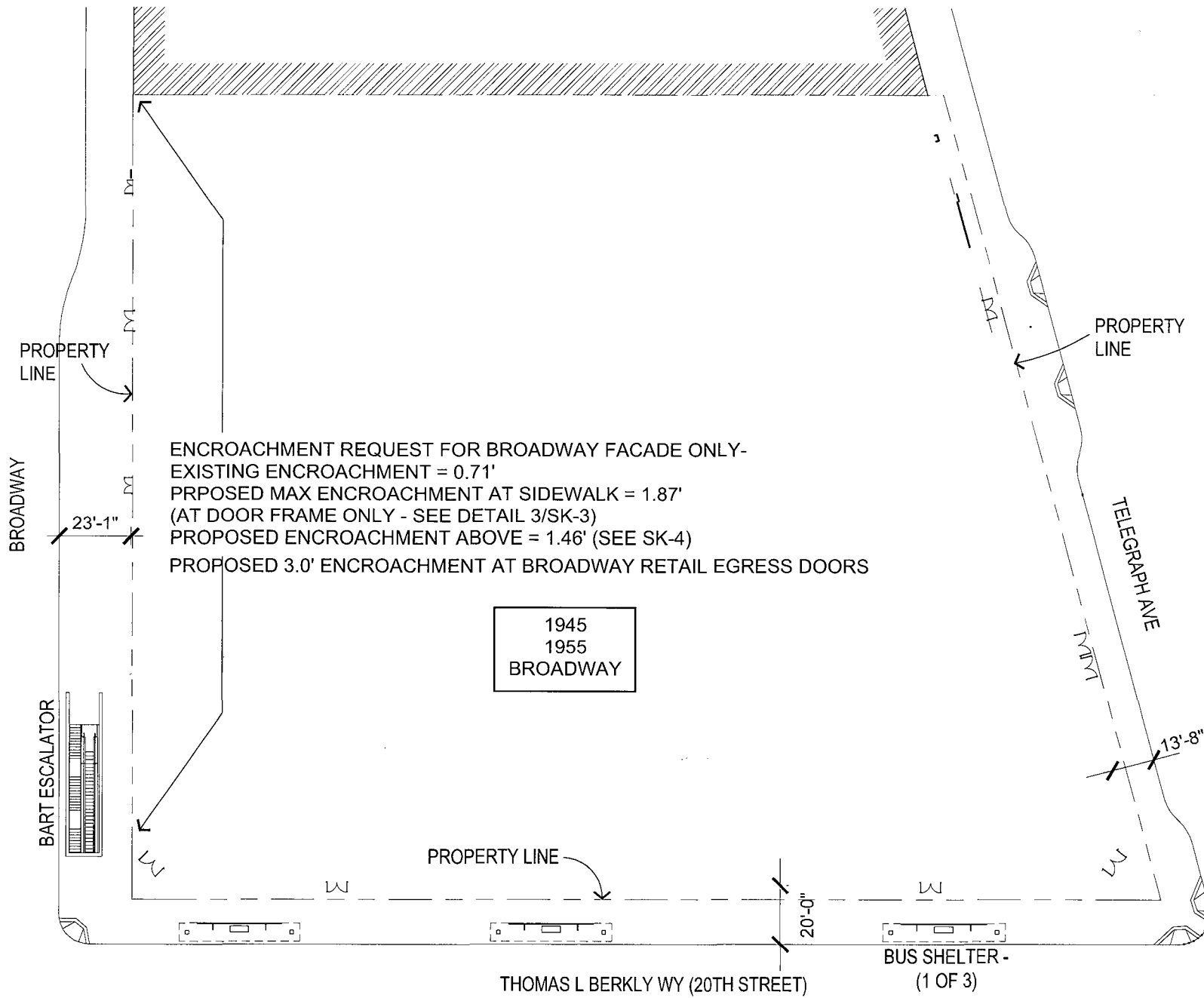

ENCROACHMENT PERMIT DIAGRAMS - GROUND FLOOR PLAN

UPTOWN STATION



SK-2

01/22/16

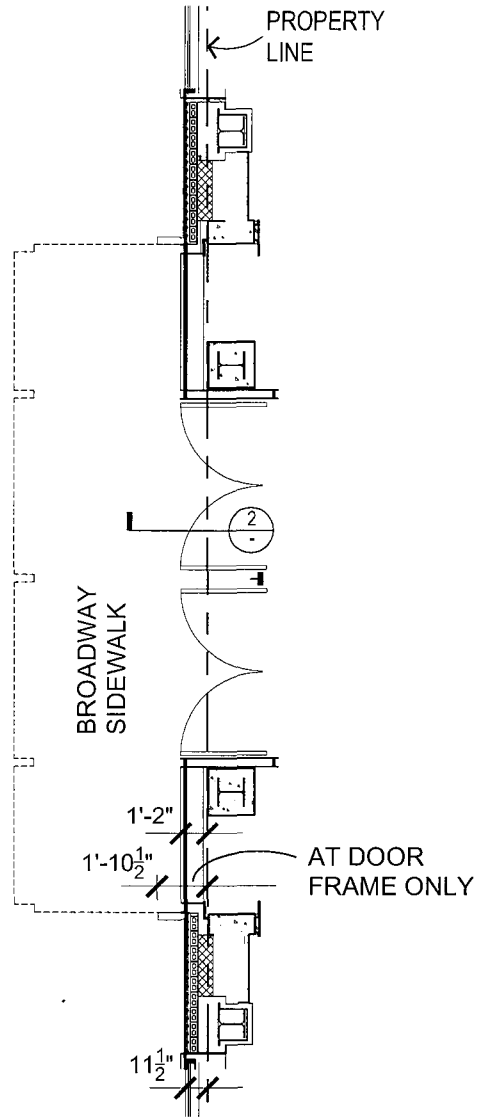

3. ENLARGED PLAN AT ENTRY
1/8" = 1'-0" PROPOSED

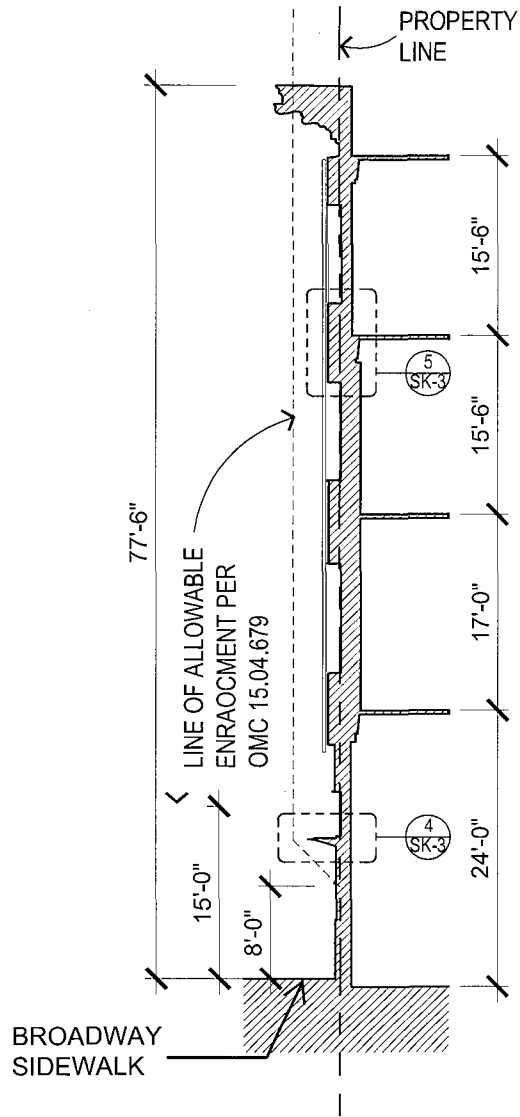

2. WALL SECTION - TYPICAL
1/16" = 1'-0" PROPOSED

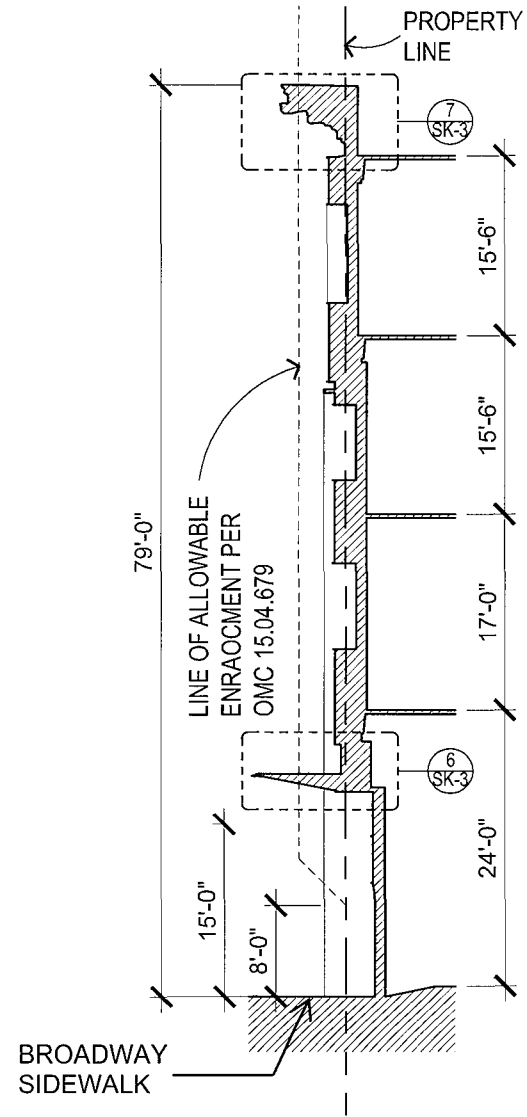

1. WALL SECTION AT ENTRY
1/16" = 1'-0" PROPOSED

EXISTING BUILDING FACADE
ENCROACHES UP TO 5" OVER
PROPERTY LINE

ENCROACHMENT PERMIT DIAGRAMS - PLAN / SECTIONS

UPTOWN STATION

SK-3
01/22/16

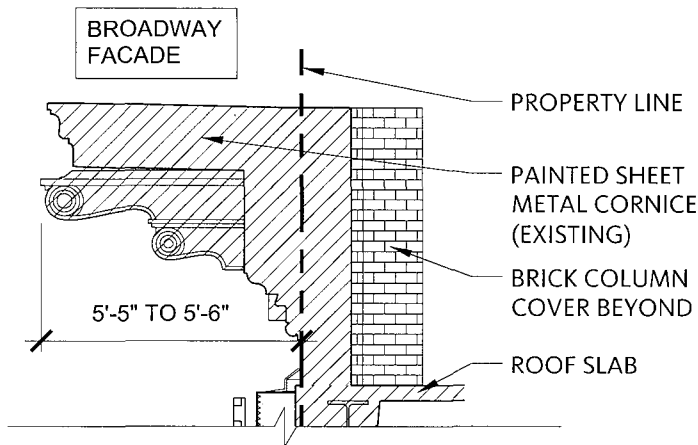

7. SECTION AT CORNICE

1/4" = 1'-0"

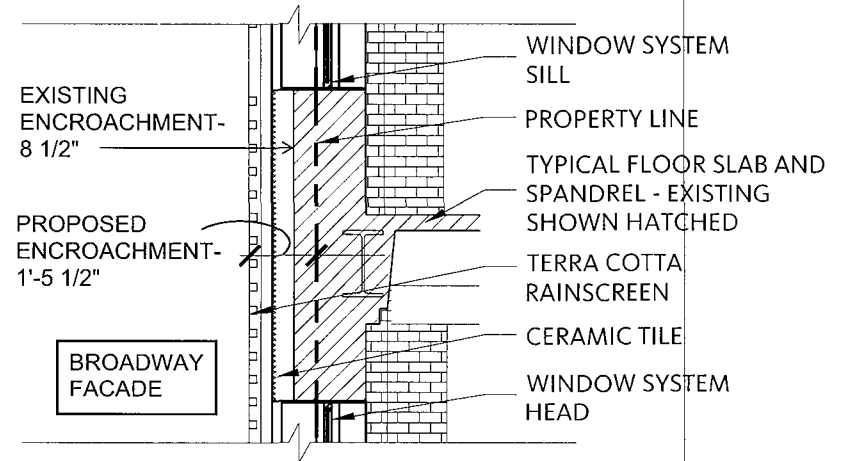

5. SECTION AT TYPICAL SPANDREL

1/4" = 1'-0"

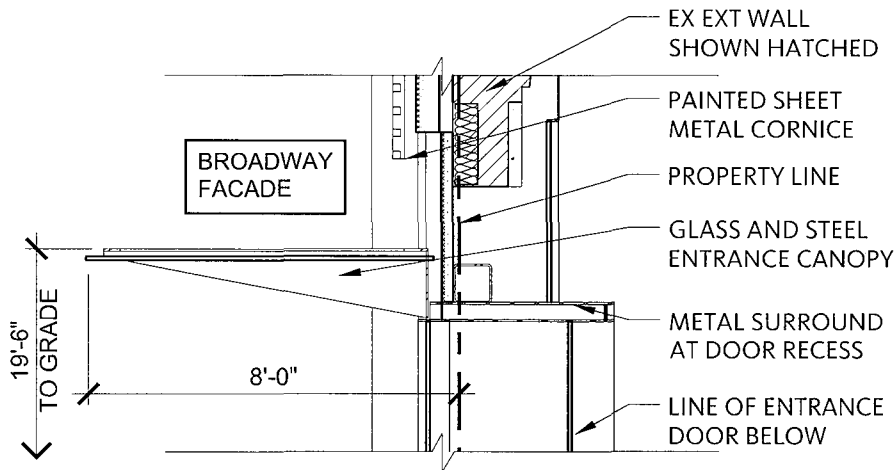

6. SECTION AT LARGE (ENTRY) CANOPY

1/4" = 1'-0"

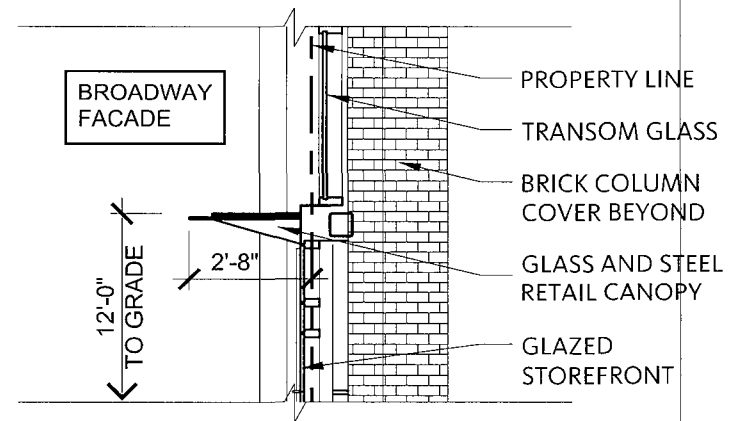

4. SECTION AT SMALL (RETAIL) CANOPY

1/4" = 1'-0"

EXISTING BUILDING FACADE
ENCROACHES UP TO 5" OVER
PROPERTY LINE

ENCROACHMENT PERMIT DIAGRAMS - DETAILS

UPTOWN STATION

FILED
OFFICE OF THE CITY CLERK
OAKLAND

OAKLAND CITY COUNCIL

Approved as to Form and Legality

2016 MAR 10 PM 12:40

RESOLUTION No. _____ C.M.S.

City Attorney

Introduced by Councilmember _____

RESOLUTION GRANTING A CONDITIONAL AND REVOCABLE MAJOR ENCROACHMENT PERMIT TO BROADWAY OAK PARTNERS LLC TO ALLOW PORTION OF THE BUILDING ABOVE GRADE AT 459 8TH STREET TO ENCROACH INTO THE PUBLIC RIGHT-OF-WAY ALONG 8TH STREET AND BROADWAY

WHEREAS, Broadway Oak Partners LLC ("Permittee"), the owner of the real property known as at 459 8th Street and described in a Grant Deed Recorded March 6, 2015 by the Alameda County Clerk-Recorder and identified by the Alameda County Assessor as APN: 001-0201-015 and commonly known 459 8th Street hereto and incorporated herein, has filed an application with Public Works for a conditional and revocable permit (ENMJ16001) to allow portions the existing building fronting 459 8th Street to encroach into the public right-of-way;

WHEREAS, the limits of the encroachment are delineated in Attachment A hereto and Incorporated herein; and

WHEREAS, the City has issued conditional and revocable major encroachment permit for encroachments into the right of way which must comply with the Oakland Municipal Code; and

WHEREAS, staff has determined, based on review of the plans and investigation of the site of the encroachment, said encroachments in the public right-of-way and their location will not interfere with public use of the roadway, sidewalk, buried utilities, and will not endanger the public welfare and convenience during said public use; and

WHEREAS, each as a separate and independent basis, this action is exempt from the California Environmental Quality Act ("CEQA") pursuant to CEQA Guidelines sections 15301(existing facilities), 15183 (projects consistent with General Plan and Zoning), and 15061(b)(3) (no significant effect on the environment); now, therefore, be it

RESOLVED: That the City Council has reviewed all relevant documents relating to its grant of the encroachment permit that is the subject of this resolution; and be it

FURTHER RESOLVED: That the City Council finds and determines that the decision made hereby is made in conformance with the requirements of CEQA; and be it

FURTHER RESOLVED: That the City Council hereby grants to the Permittee a conditional revocable major encroachment permit to allow encroach into the public right-of-way and according to the permit conditions set forth below; and be it

FURTHER RESOLVED: That said major encroachment permit is hereby conditioned by the following special requirements:

1. This agreement may be voided and the associated permit for encroachments may be revoked at any time and for any reason, at the sole discretion of the City Council, expressed by resolution as being in the City's best interest, or the associated permit may be suspended at any time, at the sole discretion of the City Engineer, upon failure of the Permittee to comply fully and continuously with each and all of the conditions set forth herein and in the associated permit.
2. The Permittee hereby disclaims any right, title, or interest in or to any portion of the public right of way, including the sidewalk and street, and agrees that the encroachment is granted for an indeterminate period of time and that the use and occupancy by the Permittee of the public right of way is temporary and does not constitute an abandonment, whether expressed or implied, by the City of Oakland of any of its rights associated with the statutory and customary purpose and use of and operations in the public right-of-way.
3. The Permittee shall maintain fully in force and effect, at its own expense, at all times during the period for which the permit is in effect, good and sufficient public liability insurance in a face amount not less than \$300,000.00 for each occurrence, and property damage insurance in a face amount not less than \$50,000.00 for each occurrence, both including contractual liability, insuring the City of Oakland, its officers, agents, employees, and volunteers against any and all claims arising out of the existence of the encroachment in the public right-of-way, as respects liabilities assumed under this permit. The policy shall contain an endorsement declaring the policy as primary coverage on said liabilities. The Permittee shall submit a written certificate of such insurance or copy of the policy to City Engineer showing that insurance is in effect in compliance with this section, and shall file subsequent notices of the renewal thereof with the City Engineer. Such certificate shall state that the insurance coverage shall not be canceled, amended or be permitted to lapse without thirty (30) days' prior written notice to City Engineer. The Permittee also agrees that the City Engineer, at his or her sole discretion, may review the type and amount of insurance required of the Permittee annually and may require the Permittee to increase the amount of and/or change the type of insurance coverage required as circumstances warrant.
4. The Permittee shall be solely and fully liable and responsible for the repair, replacement, removal, reconstruction, and maintenance of any portion or all of the private improvements constructed or installed in the public right-of-way, whether by cause, neglect, or negligence of the Permittee or others, and for the associated costs and expenses necessary to restore or remove the encroachment to the satisfaction of the City Engineer, and shall not allow the encroachment to become a blight or a menace or a hazard to the health and safety of the general public.
5. The Permittee acknowledges and agrees that the encroachment is out of the ordinary and does not comply with City of Oakland standard installations. The Permittee further acknowledges and agrees that the City of Oakland and public utility agencies will periodically conduct work in the public right-of-way, including excavation, trenching, and relocation of its facilities, all of which may damage the encroachment. The Permittee further acknowledges and agrees that the City and public utility agencies take no responsibility for repair or replacement of the encroachment which may be damaged by the City or its contractors or public utility agencies or their contractors. The Permittee further acknowledges

and agrees that upon notification by and to the satisfaction of the City Engineer, Permittee shall immediately repair, replace, or remove, at the sole expense of the Permittee, all damages to the encroachment that are directly or indirectly attributable to work by the City or its contractors or public utility agencies or their contractors.

6. The Permittee shall remain liable for and shall immediately reimburse the City of Oakland for all costs, fee assessments, penalties, and accruing interest associated with the City's notification and subsequent abatement action for required maintenance, repairs, or removal, whether in whole or in part, of the encroachment or of damaged City infrastructure made necessary by the failure, whether direct or indirect, of the Permittee to monitor the encroachment effectively and accomplish preventative, remedial, or restorative work expeditiously. The City reserves the unqualified right to collect all monies unpaid through any combination of available statutory remedies, including recordation of Prospective Liens and Priority Liens/ Special Assessments with the Alameda County Recorder, inclusion of non-reimbursed amounts by the Alameda County Assessor with the annual assessment of the general levy, and awards of judgments by a court of competent jurisdiction.
7. Upon revocation of the encroachment permit, the Permittee shall immediately, completely, and permanently remove the encroachment from the public right-of-way, repair any damage resulting therefrom, and restore the public right-of-way to its original conditions existing before the construction or installation of the encroachment, to the satisfaction of the City Engineer and all at the sole expense of the Permittee.
8. This agreement and the associated permit for an encroachment shall become effective upon filing of this agreement with the Alameda County Recorder for recordation as an encumbrance of the property and its title.
9. The Permittee acknowledges that the City makes no representations or warranties as to the conditions beneath said encroachment. By accepting this revocable permit, Permittee agrees that it will use the encroachment area at its own risk, is responsible for the proper coordination of its activities with all other permittees, underground utilities, contractors, or workmen operating, within the encroachment area and for the safety of itself and any of its personnel in connection with its entry under this revocable permit.
10. The Permittee acknowledges that the City is unaware of the existence of any hazardous substances in encroachment area, and Permittee hereby waives and fully releases and forever discharges the City and its officers, directors, employees, agents, servants, representatives, assigns and successors from any and all claims, demands, liabilities, damages, actions, causes of action, penalties, fines, liens, judgments, costs, or expenses whatsoever (including, without limitation, attorneys' fees and costs), whether direct or indirect, known or unknown, foreseen or unforeseen, that may arise out of or in any way connected with the physical condition or required remediation of the excavation area of any law or regulation applicable thereto, including, without limitation, the Comprehensive Environmental Response, Compensation and Liability Act of 1980, as amended (42 U.S.C. Sections 9601 et seq.), the Resource Conservation and Recovery Act of 1976 (42 U.S.C. Section 466 et seq.), the Safe Drinking Water Act (14 U.S.C. Sections 1401, 1450), the Hazardous Waste Control Law (California Health and Safety Code Sections 25100 et seq.), the Porter-Cologne Water Quality Control Act (California Health and Safety Code Section 13000 et seq.), the Hazardous Substance Account Act (California Health and Safety Code Sections 253000 et seq.), and the Safe Drinking Water and Toxic Enforcement Act (California Health and Safety Code Section

11. The Permittee further acknowledges that it understands and agrees that it hereby expressly waives all rights and benefits which it now has or in the future may have, under and by virtue of the terms of California Civil Code Section 1542, which reads as follows: "A GENERAL RELEASE DOES NOT EXTEND TO CLAIMS WHICH THE CREDITOR DOES NOT KNOW OR SUSPECT TO EXIST IN HIS FAVOR AT THE TIME OF EXECUTING THE RELEASE, WHICH IF KNOWN BY HIM MUST HAVE MATERIALLY AFFECTED HIS SETTLEMENT WITH THE DEBTOR." The Permittee recognizes that by waiving the provisions of this section, Permittee will not be able to make any claims for damages that may exist, and to which, if known, would materially affect its decision to agree to these encroachment terms and conditions, regardless of whether Permittee's lack of knowledge is the result of ignorance, oversight, error, negligence, or any other cause.
12. The Permittee shall, and by the acceptance of this revocable permit agrees and promises:
 - a. to indemnify, defend, save and hold harmless the City of Oakland, its officers, agents, employees, and volunteers, to the maximum extent permitted by law, from any and all suits, claims, demands, liabilities, damages, actions, causes of action, penalties, fines, liens, judgments, costs, or expenses whatsoever (including, without limitation, attorneys' fees and costs) (collectively referred to as "claims"), whether direct or indirect, known or unknown, foreseen or unforeseen, brought by any person for or on account of any bodily injuries, disease or illness or damage to persons and/or property sustained or arising in the construction of the work performed under the permit or arising out of the Permittee's failure to perform the obligations with respect to the use and occupancy of the public right-of-way by virtue of the permit, to the extent that such claims were either (1) caused by the Permittee, its agents, employees, contractors or representatives, or (2) in the case of environmental contamination, the claim is a result of environmental contamination that emanates or emanated from 459 8th Street, Oakland, California site, or was otherwise caused by the Permittee, its agents, employees, contractors or representatives; and
 - b. if any contamination is discovered below or in the immediate vicinity of the encroachment, and the contaminants found are of the type used, housed, stored, processed or sold on the property, such shall amount to a rebuttable presumption that the contamination below, or in the immediate vicinity of, the encroachment was caused by the Permittee, its agents, employees, contractors or representatives; and
 - c. Permittee shall comply with all applicable federal, state, county and local laws, rules, and regulations governing the installation, maintenance, operation and abatement of the encroachment.
13. The encroachment permit and accompanying indenture agreement shall take effect when all the conditions hereinabove set forth shall have been complied with to the satisfaction of the City Engineer, and shall become null and void upon the failure of the Permittee to comply with all conditions.
14. The Indenture Agreement alone does not allow work to be done which requires permitting and/or inspection, and the Permittee shall obtain any and all required permits before beginning work.

15. The hereinabove conditions shall be binding upon the Permittee and the successive owners and assigns thereof; and be it

FURTHER RESOLVED: That the City Council, at its sole discretion and at a future date not yet determined, may impose additional and continuing fees as prescribed in the Master Fee Schedule, for use and occupancy of the public right-of-way; and be it

FURTHER RESOLVED: That this resolution shall take effect when all the conditions hereinabove set forth shall have been complied with to the satisfaction of the City Attorney and the City Engineer of the City of Oakland and shall become null and void upon the failure of the Permittee to comply with the conditions hereinabove set forth after notice and failure to cure such conditions in a reasonable manner; and be it

FURTHER RESOLVED: That the City Engineer is hereby directed to file a certified copy of this resolution for recordation with the Office of the Alameda County Clerk-Recorder as an encumbrance of the title of the property identified above.

IN COUNCIL, OAKLAND, CALIFORNIA, _____, 20_____

PASSED BY THE FOLLOWING VOTE:

AYES - BROOKS, CAMPBELL WASHINGTON, GALLO, GUILLEN, KALB, KAPLAN, REID, and
PRESIDENT GIBSON MCELHANEY

NOES -

ABSENT -

ABSTENTION -

ATTEST: _____

LaTonda Simmons
City Clerk and Clerk of the Council
of the City of Oakland, California

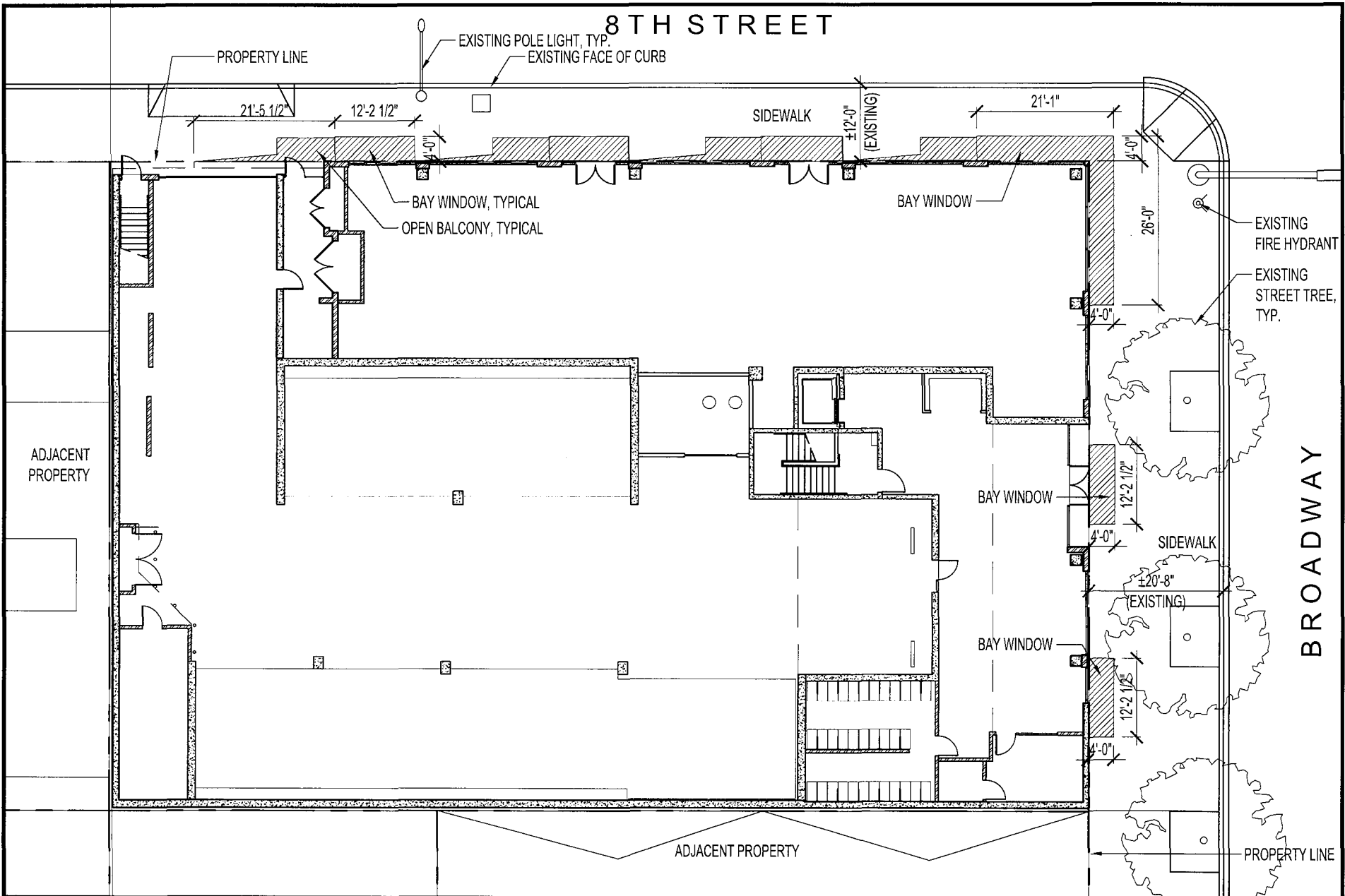

Project Name:
459 8TH STREET
 OAKLAND, CA

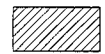
 INDICATES EXTENT OF ENCROACHMENT

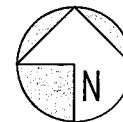

Date:
 06.15.2015

Sheet:
 ENCROACHMENT
 SITE PLAN

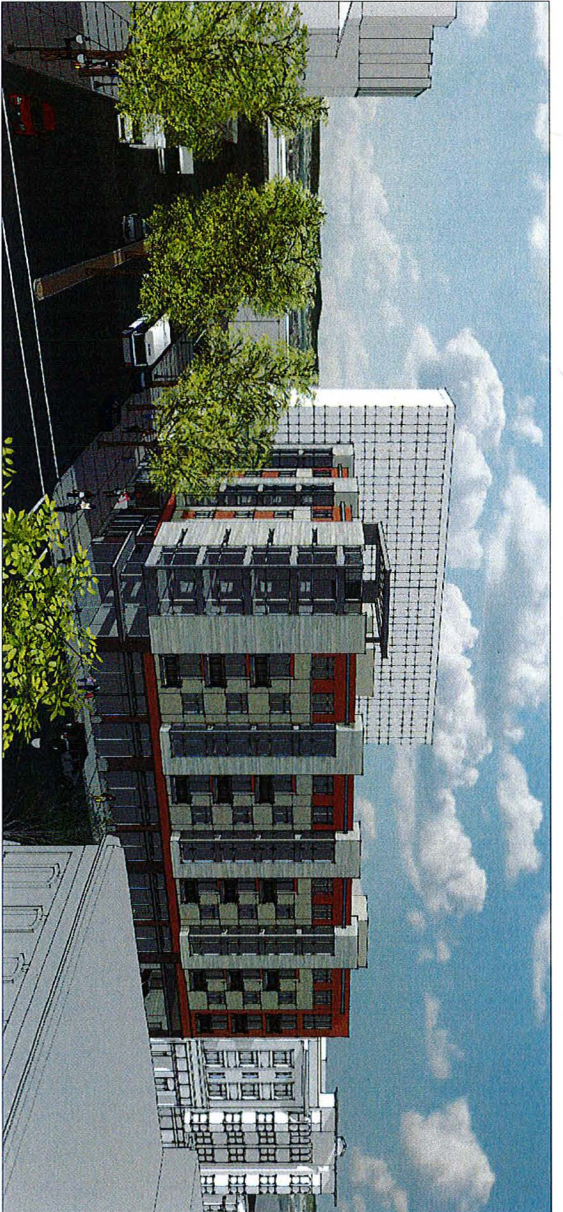

1 PROJECT VIEW, LOOKING DOWN BROADWAY TOWARDS 1480
SCALE: 1/8" = 1'-0"



2 PROJECT VIEW, LOOKING DOWN 8TH STREET TOWARDS CHINATOWN
SCALE: 1/8" = 1'-0"

2016 MAR 10 PM 12:41

RESOLUTION No. _____ C.M.S.

City Attorney

Introduced by Councilmember _____

RESOLUTION GRANTING A CONDITIONAL AND REVOCABLE MAJOR ENCROACHMENT PERMIT TO TRUSTEES CHAPEL OF THE CHIMES SPECIAL CARE FUNDS TO ALLOW PORTION OF THE BUILDING ABOVE GRADE AT 4435 PIEDMONT AVENUE TO ENCROACH INTO THE PUBLIC RIGHT-OF-WAY ALONG THE BUILDING FRONTAGE ON PIEDMONT AVENUE

WHEREAS, Trustees Chapel of the Chimes Special Care Funds ("Permittee"), the owner of the real property known as at 4435 Piedmont Avenue and described in a Grant Deed Recorded September 23, 2015 by the Alameda County Clerk-Recorder and identified by the Alameda County Assessor as APN: 013-1128-501 and commonly known as 4435 Piedmont Avenue hereto and incorporated herein, has filed an application with Public Works for a conditional and revocable permit (ENMJ15060) to allow portions the existing building fronting 4435 Piedmont Avenue to encroach into the public right-of-way;

WHEREAS, the limits of the encroachment are delineated in Attachment A hereto and Incorporated herein; and

WHEREAS, the City has issued conditional and revocable major encroachment permit for encroachments into the right of way which must comply with the Oakland Municipal Code; and

WHEREAS, staff has determined, based on review of the plans and investigation of the site of the encroachment, said encroachments in the public right-of-way and their location will not interfere with public use of the roadway, sidewalk, buried utilities, and will not endanger the public welfare and convenience during said public use; and

WHEREAS, each as a separate and independent basis, this action is exempt from the California Environmental Quality Act ("CEQA") pursuant to CEQA Guidelines sections 15301(existing facilities), 15183 (projects consistent with General Plan and Zoning), and 15061(b)(3) (no significant effect on the environment); now, therefore, be it

RESOLVED: That the City Council has reviewed all relevant documents relating to its grant of the encroachment permit that is the subject of this resolution; and be it

FURTHER RESOLVED: That the City Council finds and determines that the decision made hereby is made in conformance with the requirements of CEQA; and be it

FURTHER RESOLVED: That the City Council hereby grants to the Permittee a conditional revocable major encroachment permit to allow encroach into the public right-of-way and according to the permit conditions set forth below; and be it

FURTHER RESOLVED: That said major encroachment permit is hereby conditioned by the Following special requirements:

1. This agreement may be voided and the associated permit for encroachments may be revoked at any time and for any reason, at the sole discretion of the City Council, expressed by resolution as being in the City's best interest, or the associated permit may be suspended at any time, at the sole discretion of the City Engineer, upon failure of the Permittee to comply fully and continuously with each and all of the conditions set forth herein and in the associated permit.
2. The Permittee hereby disclaims any right, title, or interest in or to any portion of the public right of way, including the sidewalk and street, and agrees that the encroachment is granted for an indeterminate period of time and that the use and occupancy by the Permittee of the public right of way is temporary and does not constitute an abandonment, whether expressed or implied, by the City of Oakland of any of its rights associated with the statutory and customary purpose and use of and operations in the public right-of-way.
3. The Permittee shall maintain fully in force and effect, at its own expense, at all times during the period for which the permit is in effect, good and sufficient public liability insurance in a face amount not less than \$300,000.00 for each occurrence, and property damage insurance in a face amount not less than \$50,000.00 for each occurrence, both including contractual liability, insuring the City of Oakland, its officers, agents, employees, and volunteers against any and all claims arising out of the existence of the encroachment in the public right-of-way, as respects liabilities assumed under this permit. The policy shall contain an endorsement declaring the policy as primary coverage on said liabilities. The Permittee shall submit a written certificate of such insurance or copy of the policy to City Engineer showing that insurance is in effect in compliance with this section, and shall file subsequent notices of the renewal thereof with the City Engineer. Such certificate shall state that the insurance coverage shall not be canceled, amended or be permitted to lapse without thirty (30) days' prior written notice to City Engineer. The Permittee also agrees that the City Engineer, at his or her sole discretion, may review the type and amount of insurance required of the Permittee annually and may require the Permittee to increase the amount of and/or change the type of insurance coverage required as circumstances warrant.
4. The Permittee shall be solely and fully liable and responsible for the repair, replacement, removal, reconstruction, and maintenance of any portion or all of the private improvements constructed or installed in the public right-of-way, whether by cause, neglect, or negligence of the Permittee or others, and for the associated costs and expenses necessary to restore or remove the encroachment to the satisfaction of the City Engineer, and shall not allow the encroachment to become a blight or a menace or a hazard to the health and safety of the general public.
5. The Permittee acknowledges and agrees that the encroachment is out of the ordinary and does not comply with City of Oakland standard installations. The Permittee further acknowledges and agrees that the City of Oakland and public utility agencies will periodically conduct work in the public right-of-way, including excavation, trenching, and relocation of its facilities, all of which may damage the encroachment. The Permittee further acknowledges and agrees that the City and public utility agencies take no responsibility for repair or replacement of the encroachment which may be damaged by the City or its

contractors or public utility agencies or their contractors. The Permittee further acknowledges and agrees that upon notification by and to the satisfaction of the City Engineer, Permittee shall immediately repair, replace, or remove, at the sole expense of the Permittee, all damages to the encroachment that are directly or indirectly attributable to work by the City or its contractors or public utility agencies or their contractors.

6. The Permittee shall remain liable for and shall immediately reimburse the City of Oakland for all costs, fee assessments, penalties, and accruing interest associated with the City's notification and subsequent abatement action for required maintenance, repairs, or removal, whether in whole or in part, of the encroachment or of damaged City infrastructure made necessary by the failure, whether direct or indirect, of the Permittee to monitor the encroachment effectively and accomplish preventative, remedial, or restorative work expeditiously. The City reserves the unqualified right to collect all monies unpaid through any combination of available statutory remedies, including recordation of Prospective Liens and Priority Liens/ Special Assessments with the Alameda County Recorder, inclusion of non-reimbursed amounts by the Alameda County Assessor with the annual assessment of the general levy, and awards of judgments by a court of competent jurisdiction.
7. Upon revocation of the encroachment permit, the Permittee shall immediately, completely, and permanently remove the encroachment from the public right-of-way, repair any damage resulting therefrom, and restore the public right-of-way to its original conditions existing before the construction or installation of the encroachment, to the satisfaction of the City Engineer and all at the sole expense of the Permittee.
8. This agreement and the associated permit for an encroachment shall become effective upon filing of this agreement with the Alameda County Recorder for recordation as an encumbrance of the property and its title.
9. The Permittee acknowledges that the City makes no representations or warranties as to the conditions beneath said encroachment. By accepting this revocable permit, Permittee agrees that it will use the encroachment area at its own risk, is responsible for the proper coordination of its activities with all other permittees, underground utilities, contractors, or workmen operating, within the encroachment area and for the safety of itself and any of its personnel in connection with its entry under this revocable permit.
10. The Permittee acknowledges that the City is unaware of the existence of any hazardous substances in encroachment area, and Permittee hereby waives and fully releases and forever discharges the City and its officers, directors, employees, agents, servants, representatives, assigns and successors from any and all claims, demands, liabilities, damages, actions, causes of action, penalties, fines, liens, judgments, costs, or expenses whatsoever (including, without limitation, attorneys' fees and costs), whether direct or indirect, known or unknown, foreseen or unforeseen, that may arise out of or in any way connected with the physical condition or required remediation of the excavation area of any law or regulation applicable thereto, including, without limitation, the Comprehensive Environmental Response, Compensation and Liability Act of 1980, as amended (42 U.S.C. Sections 9601 et seq.), the Resource Conservation and Recovery Act of 1976 (42 U.S.C. Section 466 et seq.), the Safe Drinking Water Act (14 U.S.C. Sections 1401, 1450), the Hazardous Waste Control Law (California Health and Safety Code Sections 25100 et seq.), the Porter-Cologne Water Quality Control Act (California Health and Safety Code Section 13000 et seq.), the Hazardous Substance Account Act (California Health and Safety Code Sections 253000 et seq.), and the Safe

11. The Permittee further acknowledges that it understands and agrees that it hereby expressly waives all rights and benefits which it now has or in the future may have, under and by virtue of the terms of California Civil Code Section 1542, which reads as follows: "A GENERAL RELEASE DOES NOT EXTEND TO CLAIMS WHICH THE CREDITOR DOES NOT KNOW OR SUSPECT TO EXIST IN HIS FAVOR AT THE TIME OF EXECUTING THE RELEASE, WHICH IF KNOWN BY HIM MUST HAVE MATERIALLY AFFECTED HIS SETTLEMENT WITH THE DEBTOR." The Permittee recognizes that by waiving the provisions of this section, Permittee will not be able to make any claims for damages that may exist, and to which, if known, would materially affect its decision to agree to these encroachment terms and conditions, regardless of whether Permittee's lack of knowledge is the result of ignorance, oversight, error, negligence, or any other cause.
12. The Permittee shall, and by the acceptance of this revocable permit agrees and promises:
 - a. to indemnify, defend, save and hold harmless the City of Oakland, its officers, agents, employees, and volunteers, to the maximum extent permitted by law, from any and all suits, claims, demands, liabilities, damages, actions, causes of action, penalties, fines, liens, judgments, costs, or expenses whatsoever (including, without limitation, attorneys' fees and costs) (collectively referred to as "claims"), whether direct or indirect, known or unknown, foreseen or unforeseen, brought by any person for or on account of any bodily injuries, disease or illness or damage to persons and/or property sustained or arising in the construction of the work performed under the permit or arising out of the Permittee's failure to perform the obligations with respect to the use and occupancy of the public right-of-way by virtue of the permit, to the extent that such claims were either (1) caused by the Permittee, its agents, employees, contractors or representatives, or (2) in the case of environmental contamination, the claim is a result of environmental contamination that emanates or emanated from 4435 piedmont Avenue, Oakland, California site, or was otherwise caused by the Permittee, its agents, employees, contractors or representatives; and
 - b. if any contamination is discovered below or in the immediate vicinity of the encroachment, and the contaminants found are of the type used, housed, stored, processed or sold on the property, such shall amount to a rebuttable presumption that the contamination below, or in the immediate vicinity of, the encroachment was caused by the Permittee, its agents, employees, contractors or representatives; and
 - c. Permittee shall comply with all applicable federal, state, county and local laws, rules, and regulations governing the installation, maintenance, operation and abatement of the encroachment.
13. The encroachment permit and accompanying indenture agreement shall take effect when all the conditions hereinabove set forth shall have been complied with to the satisfaction of the City Engineer, and shall become null and void upon the failure of the Permittee to comply with all conditions.

14. The Indenture Agreement alone does not allow work to be done which requires permitting and/or inspection, and the Permittee shall obtain any and all required permits before beginning work.

15. The hereinabove conditions shall be binding upon the Permittee and the successive owners and assigns thereof; and be it

FURTHER RESOLVED: That the City Council, at its sole discretion and at a future date not yet determined, may impose additional and continuing fees as prescribed in the Master Fee Schedule, for use and occupancy of the public right-of-way; and be it

FURTHER RESOLVED: That this resolution shall take effect when all the conditions hereinabove set forth shall have been complied with to the satisfaction of the City Attorney and the City Engineer of the City of Oakland and shall become null and void upon the failure of the Permittee to comply with the conditions hereinabove set forth after notice and failure to cure such conditions in a reasonable manner; and be it

FURTHER RESOLVED: That the City Engineer is hereby directed to file a certified copy of this resolution for recordation with the Office of the Alameda County Clerk-Recorder as an encumbrance of the title of the property identified above.

IN COUNCIL, OAKLAND, CALIFORNIA, _____, 20_____

PASSED BY THE FOLLOWING VOTE:

AYES - BROOKS, CAMPBELL WASHINGTON, GALLO, GUILLEN, KALB, KAPLAN, REID, and
PRESIDENT GIBSON MCELHANEY

NOES -

ABSENT -

ABSTENTION -

ATTEST: _____

LaTonda Simmons
City Clerk and Clerk of the Council
of the City of Oakland, California

PX/PZ PERMIT

4435 PIEDMONT AVENUE

ABBREVIATIONS

- AC - ASPHALT CONCRETE
- BLOC - BUILDING CORNER
- BOLD - BUILDING LINE
- BOW - BOTTOM OF WALL
- BW - BACK OF WALK
- CL - CENTERLINE
- CLF - CHAIN LINK FENCE
- COM-PB - COMMUNICATIONS PULLBOX
- CONC - CONCRETE
- COR - CORNER
- DWC - DOMESTIC WATER
- DWG - DRAINING
- EPB - ELECTRICAL PULLBOX
- FL - FINISHED FLOOR
- FL - FLOW LINE
- FT - FOOT
- G - GROUND
- GV - GAS VALVE
- INV - INVERT
- LIP - LIP OF GUTTER
- N - NORTH
- NIS - NOT TO SCALE
- R - RADII
- RET WALL - RETAINING WALL
- SD - SOUTH
- SD - STORM DRAIN
- SS - SANITARY SEWER
- SSCO - SANITARY SEWER CLEANOUT
- SIL - SINGLE-ARM STREET LIGHT
- TC - TOP OF CURB
- TD - TRENCH DRAIN
- TOP - TOP OF WALL
- TPY - TYPICAL
- W - WEST
- W/ - WITH
- WF - WOOD FENCE
- WM - WATER METER
- WW - WATER VALVE

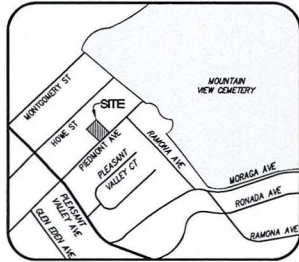

VICINITY MAP
N.T.S.

GENERAL NOTES

1. ALL TRENCHING AND STREET RESTORATION SHALL BE PER CITY STANDARD DETAIL D-22.0.
2. AS NO STORM DRAIN SYSTEM EXISTS IN PIEDMONT AVENUE, ALL DRAINAGE MUST EXIT THE BUILDING ABOVE GRADE AND DISCHARGE VIA THROUGH CURB CONNECTIONS.

BENCHMARK

THE BASIS OF ELEVATION FOR THIS SURVEY IS BM42145, A CUT SQUARE IN CURB AT CENTERLINE OF INLET OF WEST RETURN AT THE NORTHWEST CORNER OF PLEASANT VALLEY AVENUE AND PLEASANT VALLEY COURT, CITY OF OAKLAND.
ELEVATION = 153.16 FEET (OAKLAND DATUM)

BASIS OF BEARINGS

THE CONTROL FOR THIS SURVEY WAS ESTABLISHED BY A SPLIT OF THE STREET IMPROVEMENTS OF PIEDMONT AVENUE, THE BEARING OF WHICH WAS CALCULATED TO BE S60°57'00"W. THE BEARING AND COORDINATES USED FOR CALCULATIONS ARE BASED ON OUR OVERALL HORIZONTAL CONTROL FOR THE MOUNTAIN VIEW CEMETERY PROPERTY, AS UTILIZED BY SANDIS AND ESTABLISHED PREVIOUSLY BY OTHERS.

LEGEND

ALL DISTANCES AND DIMENSIONS ARE SHOWN IN FEET AND DECIMALS THEREOF.

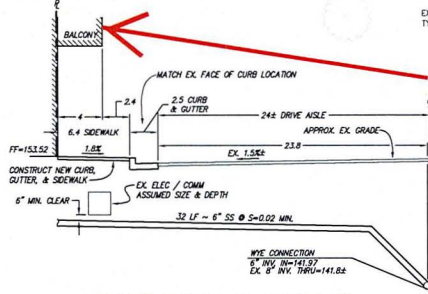

SEWER LATERAL SECTION
1"=2'

P-JOB GENERAL NOTES

1. ALL WORKS CONSTRUCTION MATERIAL AND METHODS SHALL COMPLY WITH CITY OF OAKLAND STANDARD SPECIFICATIONS AND STANDARD DETAILS FOR PUBLIC WORKS CONSTRUCTION. COPIES OF THE STANDARD SPECIFICATIONS AND THE STANDARD DETAILS WILL BE PROVIDED BY THE CITY OF OAKLAND PUBLIC WORKS DEPARTMENT WITH THE P-JOB PERMIT.
2. TYPE OF SANITARY SEWER PIPE MAY BE EXTRA STRENGTH C900 W/WRAPPED CLAY PIPE (VCP), CLASS 52 DUCTILE IRON PIPE (DIP), OR HOPE SDR-11 PIPE. TYPE OF STORM DRAIN PIPE MAY BE HOPE SDR-11 PIPE, OR CLASS 3 RCP.
3. MINIMUM COVER OVER PIPE IS 3 FEET IN EASEMENTS AND 1.5 FEET IN STREETS, OR CONCRETE BEDDING IS REQUIRED (SEE CITY OF OAKLAND STANDARD DETAIL SHEET D-1), OR CLASS 3 DUCTILE IRON PIPE IS REQUIRED.
4. CHECK DAMS AND PIPE ANCHORS MAY BE REQUIRED IF DIRECTED BY THE ENGINEER.
5. CONCRETE EROSION PROTECTION MAY BE REQUIRED IF DIRECTED BY THE ENGINEER (SEE DETAIL SHEET).
6. PAVEMENT REPLACEMENT TYPE SHALL BE THE EQUIVALENT OF EXISTING PAVEMENT SECTION OR BETTER (SEE CITY OF OAKLAND STANDARD DETAIL SHEET D-22). ALL REPLACEMENT SECTIONS SHALL COMPLY WITH CITY OF OAKLAND STANDARDS.
7. IF A CONFLICT OCCURS DURING CONSTRUCTION WHICH REQUIRES A CHANGE IN DESIGN, THE CONTRACTOR SHALL CONTACT THE PRIVATE ENGINEER, OR HIS/HER REPRESENTATIVE IN CHARGE, FOR A SOLUTION. IF SUCH A CHANGE CAN BE MADE WITHOUT DELAY, AND TO THE SATISFACTION OF THE CITY INSPECTOR, THEN THE WORK MAY PROCEED. IF A CHANGE CANNOT BE MADE WITHOUT DELAY, THEN THE CONTRACTOR SHALL STOP HIS/HER OPERATIONS UNTIL SUCH A TIME THAT THE PRIVATE ENGINEER SUBMITTED A REVISED PLAN OF THE DESIGN CHANGE TO THE CITY FOR APPROVAL. CONSTRUCTION OF THE PART OF THAT PROJECT CAN COMMENCE AFTER THE CITY HAS APPROVED THE PLAN.
8. THE PRIVATE ENGINEER OR HIS/HER REPRESENTATIVE TO CONTACT IS:
MICHAEL KUTYKENDALL
TELEPHONE NUMBER (510) 873-8866

SHEET NOTES

1. CONSTRUCT 6-INCH SANITARY SEWER LATERAL. LOCATION SHOWN IS ASSUMED. PENDING CONFIRMATION BY DESIGN BUILD PLUMBING ENGINEER. PROVIDE TWO WAY CLEANOUT AT BUILDING EXTERIOR.
2. AS THE BUILDING IS GREATER THAN 3-STORIES INDIVIDUAL METERING OF THE RESIDENTIAL UNITS IS NOT REQUIRED. PROVIDE (2) SEPARATE SERVICES: (1) FOR THE NON-RESIDENTIAL COMMERCIAL SPACE, (1) FOR THE RESIDENTIAL UNITS. SPECIFIC SIZE OF SERVICE TO BE DETERMINED BY EBMUD. LOCATION OF SERVICES IS ASSIGNED, TO BE CONFIRMED BY DESIGN BUILD PLUMBER.
3. ABOVE GRADE RPPA DEVICES ARE REQUIRED FOR DOMESTIC WATER SERVICES. DEVICES SHALL BE LEAD FREE AND APPROVED BY THE EBMUD BACKFLOW DIVISION. FEBCO, MODEL LF800, OR APPROVED EQUIVALENT.
4. FIRE SPRINKLER SERVICE. PROVIDE ABOVE GRADE BACKFLOW DEVICE IN ACCORDANCE WITH EBMUD BACKFLOW DIVISION REQUIREMENTS. FEBCO, MODEL 856, OR APPROVED EQUIVALENT.
5. ASSIGNED LOCATION OF NATURAL GAS METER. EXACT SIZE AND LOCATION TO BE DETERMINED BY PG&E.
6. ASSIGNED LOCATION OF ELECTRICAL SERVICE TRANSFORMER TO BE LOCATED WITHIN MECHANICAL ROOM, PENDING APPROVAL OF PG&E.
7. ASSIGNED LOCATION OF COMMUNICATIONS SERVICE. EXACT LOCATION TO BE DETERMINED BY COMCAST AND/OR AT&T.
8. POTENTIAL SANITARY SEWER LATERAL TO SERVE NON-RESIDENTIAL SPACE.
9. PROTECT EXISTING VAULT TO REMAIN ABOVE GRADE.
10. COLLECT STORM DRAINAGE FROM THE REAR PATIO AREAS AND ROUTE THROUGH THE BUILDING. EXACT ROUTING TO BE DETERMINED BY DESIGN BUILD PLUMBER.
11. DISCHARGE STORM DRAIN FROM REAR YARDS TO CURB DRAIN CONNECTED TO THROUGH CURB DRAIN.
12. 4" x 8" TUBE SUEL CULVERT DISCHARGING TO CURB FACE.
13. THE RUNOFF FROM THE ROOF, DECKS, AND OVERHANGS MUST BE ROUTED THROUGH A MEDIA FILTER PRIOR TO LEAVING THE PROPERTY. SEE SHEET C-2.
14. EITHER A TRENCH DRAIN OR SHALLOW PIPE WILL BE REQUIRED TO CONVEY STORMWATER FROM MEDIA FILTER TO THE STREET.
15. PROVIDE JUNCTION BOX TO TRANSITION FROM TRENCH DRAIN/PIPE TO BOX. STEEL LID OF JUNCTION BOX SHALL BE GRATED TO ALLOW FOR OVER FLOW IN THE EVENT THE THROUGH CURB DRAIN BECOMES BLOCKED.
16. RELOCATE EXISTING STREET LIGHT. PROVIDE NEW FOUNDATION PER CITY STANDARDS. CONTRACTOR TO COORDINATE RELOCATION WITH CITY OF OAKLAND.
17. STREET TREES IN 20" x 40" TREE WELL. TO MAINTAIN THE CITY REQUIRED FIVE FOOT WIDE ACCESSIBLE SIDEWALK THE TREE SHALL BE SURROUNDED BY DECOMPOSED GRANITE OR AN ADA COMPLIANT TREE GRATE.
18. EXTEND SIDEWALK REPLACEMENT TO NEAREST SCOUR JOINT. CONFIRM EXTENTS WITH CITY INSPECTION STAFF.

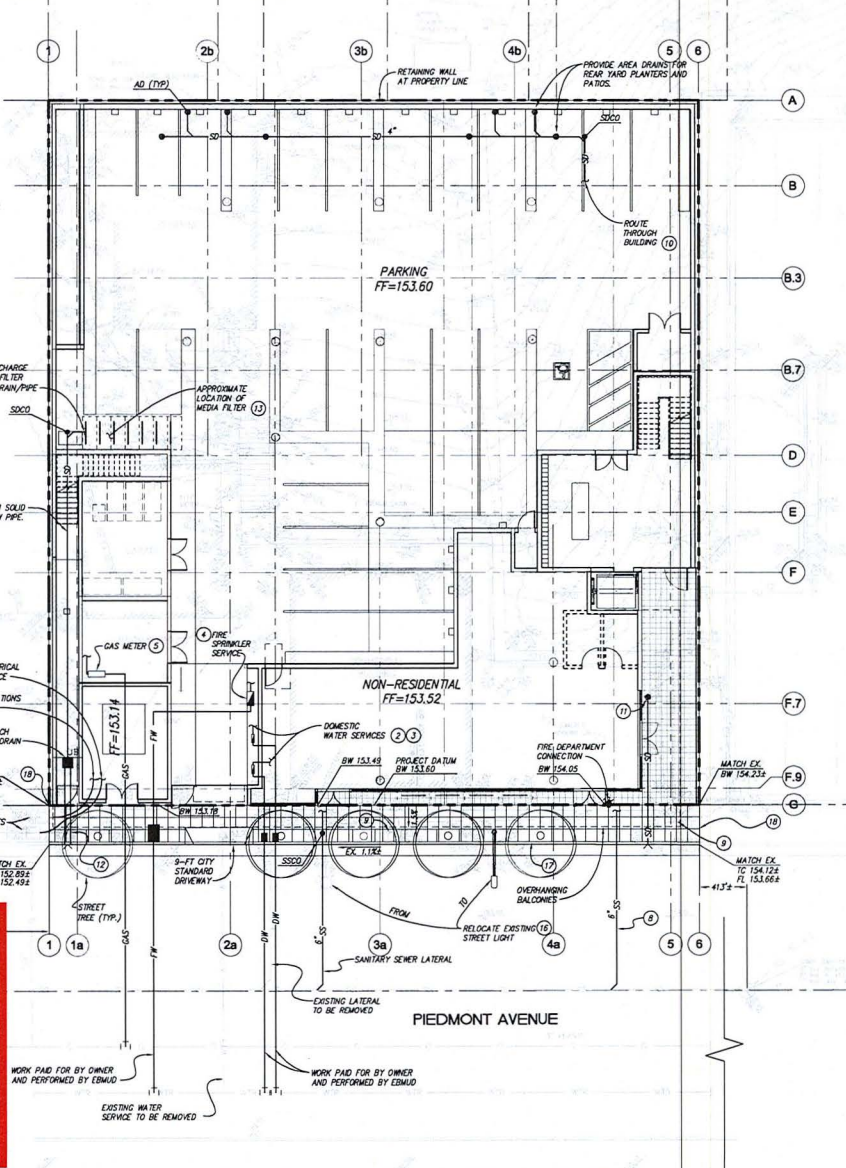

Major Encroachment into the right of way for above ground encroachment on Piedmont Avenue. Balcony and windows start at 12 feet above ground and 4 feet into the right of way.

There is no encroachment at sidewalk grade.

SANDIS CIVIL ENGINEERS

108 Ninth Street | Oakland, CA 94607 | P. 510.873.8866 | www.sandis.net
SILICON VALLEY TRI-VALLEY CENTRAL VALLEY EAST BAY/SF

No.	REVISION	DATE	BY

4435 PIEDMONT AVENUE
GRADING AND UTILITY PLAN

OAKLAND CALIFORNIA

SHEET
C-1
OF 3 SHEETS

File: X:\P\614050\PLAN SETS\PERMITTING\PZ-PX PERMIT\1-Long Date: Aug 10, 2015 - 1:19 PM

2016 MAR 10 PM 12:41

RESOLUTION No. _____ C.M.S.

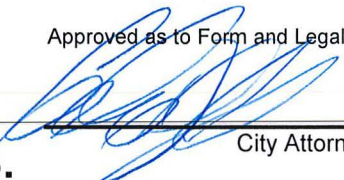
City Attorney

Introduced by Councilmember _____

RESOLUTION GRANTING A CONDITIONAL AND REVOCABLE MAJOR ENCROACHMENT PERMIT TO 265 VERNON STREET, LLC TO ALLOW PORTION OF THE BUILDING ABOVE SIDEWALK AT 459 23RD STREET TO ENCROACH INTO THE PUBLIC RIGHT-OF-WAY ALONG THE BUILDING FRONTAGE ON 23RD STREET AND VALLEY STREET

WHEREAS, 265 Vernon Street, LLC ("Permittee"), the owner of the real property known as at 459 23rd Street and described in a Grant Deed Recorded on April 22, 2015 by the Alameda County Clerk-Recorder and identified by the Alameda County Assessor as APN: 008-0658-004-01 and APN: 008-0658-002-01 and commonly known as 459 23rd Street hereto and incorporated herein, has filed an application with Public Works for a conditional and revocable permit (ENMJ16003) to allow portions the existing building fronting 459 23rd Street to encroach into the public right-of-way;

WHEREAS, the limits of the encroachment are delineated in Attachment A hereto and Incorporated herein; and

WHEREAS, the City has issued conditional and revocable major encroachment permit for encroachments into the right of way which must comply with the Oakland Municipal Code; and

WHEREAS, staff has determined, based on review of the plans and investigation of the site of the encroachment, said encroachments in the public right-of-way and their location will not interfere with public use of the roadway, sidewalk, buried utilities, and will not endanger the public welfare and convenience during said public use; and

WHEREAS, each as a separate and independent basis, this action is exempt from the California Environmental Quality Act ("CEQA") pursuant to CEQA Guidelines sections 15301(existing facilities), 15183 (projects consistent with General Plan and Zoning), and 15061(b)(3) (no significant effect on the environment); now, therefore, be it

RESOLVED: That the City Council has reviewed all relevant documents relating to its grant of the encroachment permit that is the subject of this resolution; and be it

FURTHER RESOLVED: That the City Council finds and determines that the decision made hereby is made in conformance with the requirements of CEQA; and be it

FURTHER RESOLVED: That the City Council hereby grants to the Permittee a conditional revocable major encroachment permit to allow encroach into the public right-of-way and according to the permit conditions set forth below; and be it

FURTHER RESOLVED: That said major encroachment permit is hereby conditioned by the following special requirements:

1. This agreement may be voided and the associated permit for encroachments may be revoked at any time and for any reason, at the sole discretion of the City Council, expressed by resolution as being in the City's best interest, or the associated permit may be suspended at any time, at the sole discretion of the City Engineer, upon failure of the Permittee to comply fully and continuously with each and all of the conditions set forth herein and in the associated permit.
2. The Permittee hereby disclaims any right, title, or interest in or to any portion of the public right of way, including the sidewalk and street, and agrees that the encroachment is granted for an indeterminate period of time and that the use and occupancy by the Permittee of the public right of way is temporary and does not constitute an abandonment, whether expressed or implied, by the City of Oakland of any of its rights associated with the statutory and customary purpose and use of and operations in the public right-of-way.
3. The Permittee shall maintain fully in force and effect, at its own expense, at all times during the period for which the permit is in effect, good and sufficient public liability insurance in a face amount not less than \$300,000.00 for each occurrence, and property damage insurance in a face amount not less than \$50,000.00 for each occurrence, both including contractual liability, insuring the City of Oakland, its officers, agents, employees, and volunteers against any and all claims arising out of the existence of the encroachment in the public right-of-way, as respects liabilities assumed under this permit. The policy shall contain an endorsement declaring the policy as primary coverage on said liabilities. The Permittee shall submit a written certificate of such insurance or copy of the policy to City Engineer showing that insurance is in effect in compliance with this section, and shall file subsequent notices of the renewal thereof with the City Engineer. Such certificate shall state that the insurance coverage shall not be canceled, amended or be permitted to lapse without thirty (30) days' prior written notice to City Engineer. The Permittee also agrees that the City Engineer, at his or her sole discretion, may review the type and amount of insurance required of the Permittee annually and may require the Permittee to increase the amount of and/or change the type of insurance coverage required as circumstances warrant.
4. The Permittee shall be solely and fully liable and responsible for the repair, replacement, removal, reconstruction, and maintenance of any portion or all of the private improvements constructed or installed in the public right-of-way, whether by cause, neglect, or negligence of the Permittee or others, and for the associated costs and expenses necessary to restore or remove the encroachment to the satisfaction of the City Engineer, and shall not allow the encroachment to become a blight or a menace or a hazard to the health and safety of the general public.
5. The Permittee acknowledges and agrees that the encroachment is out of the ordinary and does not comply with City of Oakland standard installations. The Permittee further acknowledges and agrees that the City of Oakland and public utility agencies will periodically conduct work in the public right-of-way, including excavation, trenching, and relocation of its facilities, all of which may damage the encroachment. The Permittee further acknowledges and agrees that the City and public utility agencies take no responsibility for repair or replacement of the encroachment which may be damaged by the City or its

contractors or public utility agencies or their contractors. The Permittee further acknowledges and agrees that upon notification by and to the satisfaction of the City Engineer, Permittee shall immediately repair, replace, or remove, at the sole expense of the Permittee, all damages to the encroachment that are directly or indirectly attributable to work by the City or its contractors or public utility agencies or their contractors.

6. The Permittee shall remain liable for and shall immediately reimburse the City of Oakland for all costs, fee assessments, penalties, and accruing interest associated with the City's notification and subsequent abatement action for required maintenance, repairs, or removal, whether in whole or in part, of the encroachment or of damaged City infrastructure made necessary by the failure, whether direct or indirect, of the Permittee to monitor the encroachment effectively and accomplish preventative, remedial, or restorative work expeditiously. The City reserves the unqualified right to collect all monies unpaid through any combination of available statutory remedies, including recordation of Prospective Liens and Priority Liens/ Special Assessments with the Alameda County Recorder, inclusion of non-reimbursed amounts by the Alameda County Assessor with the annual assessment of the general levy, and awards of judgments by a court of competent jurisdiction.
7. Upon revocation of the encroachment permit, the Permittee shall immediately, completely, and permanently remove the encroachment from the public right-of-way, repair any damage resulting therefrom, and restore the public right-of-way to its original conditions existing before the construction or installation of the encroachment, to the satisfaction of the City Engineer and all at the sole expense of the Permittee.
8. This agreement and the associated permit for an encroachment shall become effective upon filing of this agreement with the Alameda County Recorder for recordation as an encumbrance of the property and its title.
9. The Permittee acknowledges that the City makes no representations or warranties as to the conditions beneath said encroachment. By accepting this revocable permit, Permittee agrees that it will use the encroachment area at its own risk, is responsible for the proper coordination of its activities with all other permittees, underground utilities, contractors, or workmen operating, within the encroachment area and for the safety of itself and any of its personnel in connection with its entry under this revocable permit.
10. The Permittee acknowledges that the City is unaware of the existence of any hazardous substances in encroachment area, and Permittee hereby waives and fully releases and forever discharges the City and its officers, directors, employees, agents, servants, representatives, assigns and successors from any and all claims, demands, liabilities, damages, actions, causes of action, penalties, fines, liens, judgments, costs, or expenses whatsoever (including, without limitation, attorneys' fees and costs), whether direct or indirect, known or unknown, foreseen or unforeseen, that may arise out of or in any way connected with the physical condition or required remediation of the excavation area of any law or regulation applicable thereto, including, without limitation, the Comprehensive Environmental Response, Compensation and Liability Act of 1980, as amended (42 U.S.C. Sections 9601 et seq.), the Resource Conservation and Recovery Act of 1976 (42 U.S.C. Section 466 et seq.), the Safe Drinking Water Act (14 U.S.C. Sections 1401, 1450), the Hazardous Waste Control Law (California Health and Safety Code Sections 25100 et seq.), the Porter-Cologne Water Quality Control Act (California Health and Safety Code Section 13000 et seq.), the Hazardous Substance Account Act (California Health and Safety Code Sections 253000 et seq.), and the Safe

-
11. The Permittee further acknowledges that it understands and agrees that it hereby expressly waives all rights and benefits which it now has or in the future may have, under and by virtue of the terms of California Civil Code Section 1542, which reads as follows: "A GENERAL RELEASE DOES NOT EXTEND TO CLAIMS WHICH THE CREDITOR DOES NOT KNOW OR SUSPECT TO EXIST IN HIS FAVOR AT THE TIME OF EXECUTING THE RELEASE, WHICH IF KNOWN BY HIM MUST HAVE MATERIALLY AFFECTED HIS SETTLEMENT WITH THE DEBTOR." The Permittee recognizes that by waiving the provisions of this section, Permittee will not be able to make any claims for damages that may exist, and to which, if known, would materially affect its decision to agree to these encroachment terms and conditions, regardless of whether Permittee's lack of knowledge is the result of ignorance, oversight, error, negligence, or any other cause.
 12. The Permittee shall, and by the acceptance of this revocable permit agrees and promises:
 - a. to indemnify, defend, save and hold harmless the City of Oakland, its officers, agents, employees, and volunteers, to the maximum extent permitted by law, from any and all suits, claims, demands, liabilities, damages, actions, causes of action, penalties, fines, liens, judgments, costs, or expenses whatsoever (including, without limitation, attorneys' fees and costs) (collectively referred to as "claims"), whether direct or indirect, known or unknown, foreseen or unforeseen, brought by any person for or on account of any bodily injuries, disease or illness or damage to persons and/or property sustained or arising in the construction of the work performed under the permit or arising out of the Permittee's failure to perform the obligations with respect to the use and occupancy of the public right-of-way by virtue of the permit, to the extent that such claims were either (1) caused by the Permittee, its agents, employees, contractors or representatives, or (2) in the case of environmental contamination, the claim is a result of environmental contamination that emanates or emanated from 459 23rd Street, Oakland, California site, or was otherwise caused by the Permittee, its agents, employees, contractors or representatives; and
 - b. if any contamination is discovered below or in the immediate vicinity of the encroachment, and the contaminants found are of the type used, housed, stored, processed or sold on the property, such shall amount to a rebuttable presumption that the contamination below, or in the immediate vicinity of, the encroachment was caused by the Permittee, its agents, employees, contractors or representatives; and
 - c. Permittee shall comply with all applicable federal, state, county and local laws, rules, and regulations governing the installation, maintenance, operation and abatement of the encroachment.
 13. The encroachment permit and accompanying indenture agreement shall take effect when all the conditions hereinabove set forth shall have been complied with to the satisfaction of the City Engineer, and shall become null and void upon the failure of the Permittee to comply with all conditions.
 14. The Indenture Agreement alone does not allow work to be done which requires permitting and/or inspection, and the Permittee shall obtain any and all required permits before beginning work.

15. The hereinabove conditions shall be binding upon the Permittee and the successive owners and assigns thereof; and be it

FURTHER RESOLVED: That the City Council, at its sole discretion and at a future date not yet determined, may impose additional and continuing fees as prescribed in the Master Fee Schedule, for use and occupancy of the public right-of-way; and be it

FURTHER RESOLVED: That this resolution shall take effect when all the conditions hereinabove set forth shall have been complied with to the satisfaction of the City Attorney and the City Engineer of the City of Oakland and shall become null and void upon the failure of the Permittee to comply with the conditions hereinabove set forth after notice and failure to cure such conditions in a reasonable manner; and be it

FURTHER RESOLVED: That the City Engineer is hereby directed to file a certified copy of this resolution for recordation with the Office of the Alameda County Clerk-Recorder as an encumbrance of the title of the property identified above.

IN COUNCIL, OAKLAND, CALIFORNIA, _____, 20_____

PASSED BY THE FOLLOWING VOTE:

AYES - BROOKS, CAMPBELL WASHINGTON, GALLO, GUILLEN, KALB, KAPLAN, REID, and
PRESIDENT GIBSON MCELHANEY

NOES -

ABSENT -

ABSTENTION -

ATTEST: _____

LaTonda Simmons
City Clerk and Clerk of the Council
of the City of Oakland, California

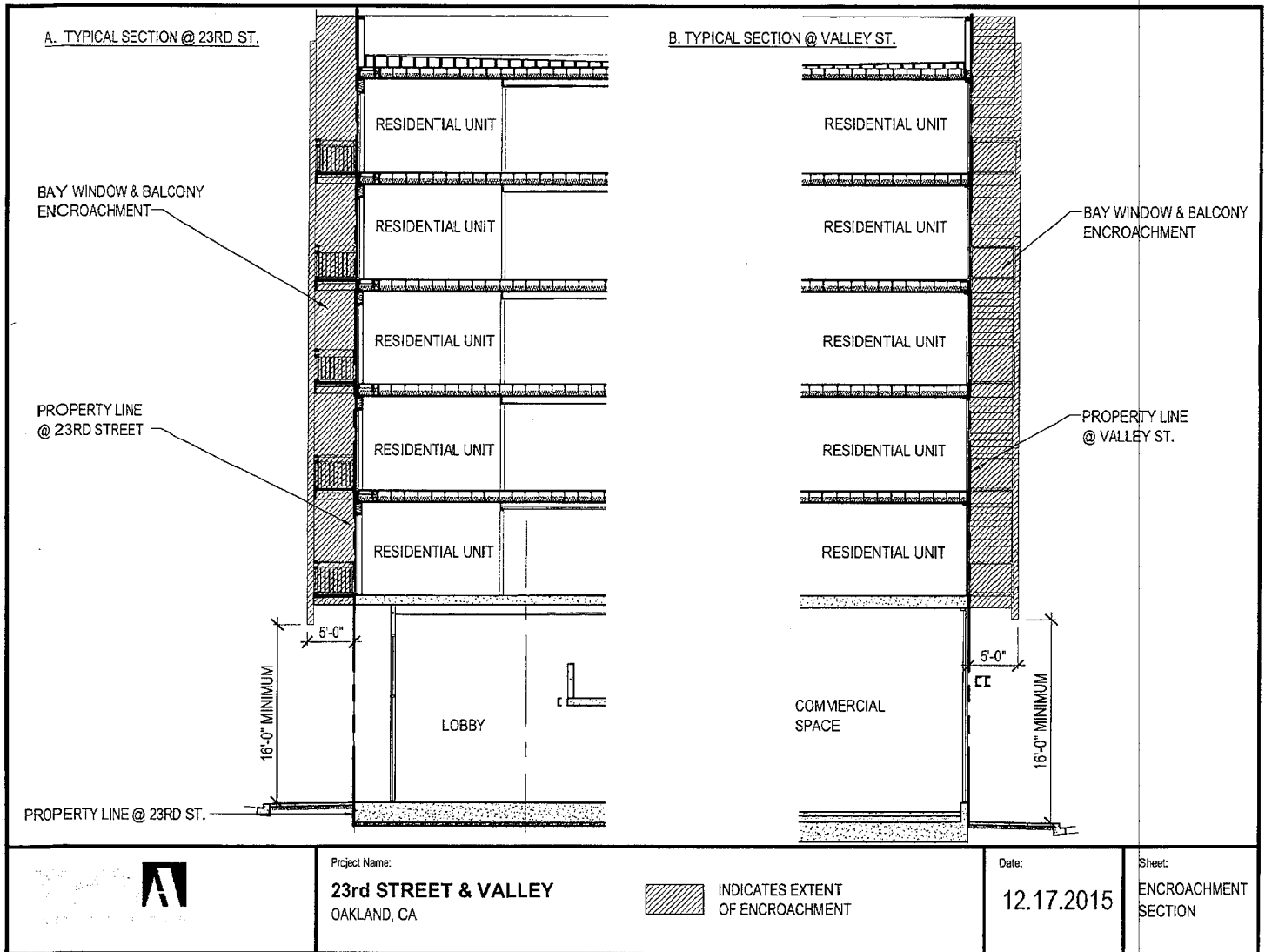

FILED
OFFICE OF THE CITY CLERK
OAKLAND

OAKLAND CITY COUNCIL

Approved as to Form and Legality

2016 MAR 10 PM 12:41

RESOLUTION No. _____ C.M.S.

City Attorney

Introduced by Councilmember _____

RESOLUTION GRANTING A CONDITIONAL AND REVOCABLE MAJOR ENCROACHMENT PERMIT TO TEMESCAL INVESTORS, LLC TO ALLOW PORTION OF THE BUILDING ABOVE GRADE AT 5239 CLAREMONT AVENUE TO ENCROACH INTO THE PUBLIC RIGHT-OF-WAY ALONG THE BUILDING FRONTAGE ON TELEGRAPH AVENUE

WHEREAS, Temescal Investors, LLC ("Permittee"), the owner of the real property known as at 5239 Claremont Avenue and described in a Grant Deed Recorded on July 7, 2015 by the Alameda County Clerk-Recorder and identified by the Alameda County Assessor as APN: 014-1225-015-01 and Grant Deed Recorded on May 16, 2014 by the Alameda County Clerk-Recorder and identified by the Alameda County Assessor as APN: 014-1225-015-01 and 014-1225-014 and commonly known as 5239 Claremont Avenue hereto and incorporated herein, has filed an application with Public Works for a conditional and revocable permit (ENMJ16002) to allow portions the existing building fronting 5239 Claremont Avenue to encroach into the public right-of-way;

WHEREAS, the limits of the encroachment are delineated in Attachment A hereto and Incorporated herein; and

WHEREAS, the City has issued conditional and revocable major encroachment permit for encroachments into the right of way which must comply with the Oakland Municipal Code; and

WHEREAS, staff has determined, based on review of the plans and investigation of the site of the encroachment, said encroachments in the public right-of-way and their location will not interfere with public use of the roadway, sidewalk, buried utilities, and will not endanger the public welfare and convenience during said public use; and

WHEREAS, each as a separate and independent basis, this action is exempt from the California Environmental Quality Act ("CEQA") pursuant to CEQA Guidelines sections 15301(existing facilities), 15183 (projects consistent with General Plan and Zoning), and 15061(b)(3) (no significant effect on the environment); now, therefore, be it

RESOLVED: That the City Council has reviewed all relevant documents relating to its grant of the encroachment permit that is the subject of this resolution; and be it

FURTHER RESOLVED: That the City Council finds and determines that the decision made hereby is made in conformance with the requirements of CEQA; and be it

FURTHER RESOLVED: That the City Council hereby grants to the Permittee a conditional revocable major encroachment permit to allow encroach into the public right-of-way and according to the permit conditions set forth below; and be it

FURTHER RESOLVED: That said major encroachment permit is hereby conditioned by the Following special requirements:

1. This agreement may be voided and the associated permit for encroachments may be revoked at any time and for any reason, at the sole discretion of the City Council, expressed by resolution as being in the City's best interest, or the associated permit may be suspended at any time, at the sole discretion of the City Engineer, upon failure of the Permittee to comply fully and continuously with each and all of the conditions set forth herein and in the associated permit.
2. The Permittee hereby disclaims any right, title, or interest in or to any portion of the public right of way, including the sidewalk and street, and agrees that the encroachment is granted for an indeterminate period of time and that the use and occupancy by the Permittee of the public right of way is temporary and does not constitute an abandonment, whether expressed or implied, by the City of Oakland of any of its rights associated with the statutory and customary purpose and use of and operations in the public right-of-way.
3. The Permittee shall maintain fully in force and effect, at its own expense, at all times during the period for which the permit is in effect, good and sufficient public liability insurance in a face amount not less than \$300,000.00 for each occurrence, and property damage insurance in a face amount not less than \$50,000.00 for each occurrence, both including contractual liability, insuring the City of Oakland, its officers, agents, employees, and volunteers against any and all claims arising out of the existence of the encroachment in the public right-of-way, as respects liabilities assumed under this permit. The policy shall contain an endorsement declaring the policy as primary coverage on said liabilities. The Permittee shall submit a written certificate of such insurance or copy of the policy to City Engineer showing that insurance is in effect in compliance with this section, and shall file subsequent notices of the renewal thereof with the City Engineer. Such certificate shall state that the insurance coverage shall not be canceled, amended or be permitted to lapse without thirty (30) days' prior written notice to City Engineer. The Permittee also agrees that the City Engineer, at his or her sole discretion, may review the type and amount of insurance required of the Permittee annually and may require the Permittee to increase the amount of and/or change the type of insurance coverage required as circumstances warrant.
4. The Permittee shall be solely and fully liable and responsible for the repair, replacement, removal, reconstruction, and maintenance of any portion or all of the private improvements constructed or installed in the public right-of-way, whether by cause, neglect, or negligence of the Permittee or others, and for the associated costs and expenses necessary to restore or remove the encroachment to the satisfaction of the City Engineer, and shall not allow the encroachment to become a blight or a menace or a hazard to the health and safety of the general public.
5. The Permittee acknowledges and agrees that the encroachment is out of the ordinary and does not comply with City of Oakland standard installations. The Permittee further acknowledges and agrees that the City of Oakland and public utility agencies will periodically conduct work in the public right-of-way, including excavation, trenching, and

relocation of its facilities, all of which may damage the encroachment. The Permittee further acknowledges and agrees that the City and public utility agencies take no responsibility for repair or replacement of the encroachment which may be damaged by the City or its contractors or public utility agencies or their contractors. The Permittee further acknowledges and agrees that upon notification by and to the satisfaction of the City Engineer, Permittee shall immediately repair, replace, or remove, at the sole expense of the Permittee, all damages to the encroachment that are directly or indirectly attributable to work by the City or its contractors or public utility agencies or their contractors.

6. The Permittee shall remain liable for and shall immediately reimburse the City of Oakland for all costs, fee assessments, penalties, and accruing interest associated with the City's notification and subsequent abatement action for required maintenance, repairs, or removal, whether in whole or in part, of the encroachment or of damaged City infrastructure made necessary by the failure, whether direct or indirect, of the Permittee to monitor the encroachment effectively and accomplish preventative, remedial, or restorative work expeditiously. The City reserves the unqualified right to collect all monies unpaid through any combination of available statutory remedies, including recordation of Prospective Liens and Priority Liens/ Special Assessments with the Alameda County Recorder, inclusion of non-reimbursed amounts by the Alameda County Assessor with the annual assessment of the general levy, and awards of judgments by a court of competent jurisdiction.
7. Upon revocation of the encroachment permit, the Permittee shall immediately, completely, and permanently remove the encroachment from the public right-of-way, repair any damage resulting therefrom, and restore the public right-of-way to its original conditions existing before the construction or installation of the encroachment, to the satisfaction of the City Engineer and all at the sole expense of the Permittee.
8. This agreement and the associated permit for an encroachment shall become effective upon filing of this agreement with the Alameda County Recorder for recordation as an encumbrance of the property and its title.
9. The Permittee acknowledges that the City makes no representations or warranties as to the conditions beneath said encroachment. By accepting this revocable permit, Permittee agrees that it will use the encroachment area at its own risk, is responsible for the proper coordination of its activities with all other permittees, underground utilities, contractors, or workmen operating, within the encroachment area and for the safety of itself and any of its personnel in connection with its entry under this revocable permit.
10. The Permittee acknowledges that the City is unaware of the existence of any hazardous substances in encroachment area, and Permittee hereby waives and fully releases and forever discharges the City and its officers, directors, employees, agents, servants, representatives, assigns and successors from any and all claims, demands, liabilities, damages, actions, causes of action, penalties, fines, liens, judgments, costs, or expenses whatsoever (including, without limitation, attorneys' fees and costs), whether direct or indirect, known or unknown, foreseen or unforeseen, that may arise out of or in any way connected with the physical condition or required remediation of the excavation area of any law or regulation applicable thereto, including, without limitation, the Comprehensive Environmental Response, Compensation and Liability Act of 1980, as amended (42 U.S.C. Sections 9601 et seq.), the Resource Conservation and Recovery Act of 1976 (42 U.S.C. Section 466 et seq.), the Safe Drinking Water Act (14 U.S.C. Sections 1401,1450), the Hazardous Waste Control Law (California

Health and Safety Code Sections 25100 et seq.), the Porter-Cologne Water Quality Control Act (California Health and Safety Code Section 13000 et seq.), the Hazardous Substance Account Act (California Health and Safety Code Sections 253000 et seq.), and the Safe Drinking Water and Toxic Enforcement Act (California Health and Safety Code Section 25249.5 et seq.).

11. The Permittee further acknowledges that it understands and agrees that it hereby expressly waives all rights and benefits which it now has or in the future may have, under and by virtue of the terms of California Civil Code Section 1542, which reads as follows: "A GENERAL RELEASE DOES NOT EXTEND TO CLAIMS WHICH THE CREDITOR DOES NOT KNOW OR SUSPECT TO EXIST IN HIS FAVOR AT THE TIME OF EXECUTING THE RELEASE, WHICH IF KNOWN BY HIM MUST HAVE MATERIALLY AFFECTED HIS SETTLEMENT WITH THE DEBTOR." The Permittee recognizes that by waiving the provisions of this section. Permittee will not be able to make any claims for damages that may exist, and to which, if known, would materially affect its decision to agree to these encroachment terms and conditions, regardless of whether Permittee's lack of knowledge is the result of ignorance, oversight, error, negligence, or any other cause.
12. The Permittee shall, and by the acceptance of this revocable permit agrees and promises:
 - a. to indemnify, defend, save and hold harmless the City of Oakland, its officers, agents, employees, and volunteers, to the maximum extent permitted by law, from any and all suits, claims, demands, liabilities, damages, actions, causes of action, penalties, fines, liens, judgments, costs, or expenses whatsoever (including, without limitation, attorneys' fees and costs) (collectively referred to as "claims"), whether direct or indirect, known or unknown, foreseen or unforeseen, brought by any person for or on account of any bodily injuries, disease or illness or damage to persons and/or property sustained or arising in the construction of the work performed under the permit or arising out of the Permittee's failure to perform the obligations with respect to the use and occupancy of the public right-of-way by virtue of the permit, to the extent that such claims were either (1) caused by the Permittee, its agents, employees, contractors or representatives, or (2) in the case of environmental contamination, the claim is a result of environmental contamination that emanates or emanated from 5239 Claremont Avenue, Oakland, California site, or was otherwise caused by the Permittee, its agents, employees, contractors or representatives; and
 - b. if any contamination is discovered below or in the immediate vicinity of the encroachment, and the contaminants found are of the type used, housed, stored, processed or sold on the property, such shall amount to a rebuttable presumption that the contamination below, or in the immediate vicinity of, the encroachment was caused by the Permittee, its agents, employees, contractors or representatives; and
 - c. Permittee shall comply with all applicable federal, state, county and local laws, rules, and regulations governing the installation, maintenance, operation and abatement of the encroachment.
13. The encroachment permit and accompanying indenture agreement shall take effect when all the conditions hereinabove set forth shall have been complied with to the satisfaction of the City Engineer, and shall become null and void upon the failure of the Permittee to comply with all conditions.

14. The Indenture Agreement alone does not allow work to be done which requires permitting and/or inspection, and the Permittee shall obtain any and all required permits before beginning work.

15. The hereinabove conditions shall be binding upon the Permittee and the successive owners and assigns thereof; and be it

FURTHER RESOLVED: That the City Council, at its sole discretion and at a future date not yet determined, may impose additional and continuing fees as prescribed in the Master Fee Schedule, for use and occupancy of the public right-of-way; and be it

FURTHER RESOLVED: That this resolution shall take effect when all the conditions hereinabove set forth shall have been complied with to the satisfaction of the City Attorney and the City Engineer of the City of Oakland and shall become null and void upon the failure of the Permittee to comply with the conditions hereinabove set forth after notice and failure to cure such conditions in a reasonable manner; and be it

FURTHER RESOLVED: That the City Engineer is hereby directed to file a certified copy of this resolution for recordation with the Office of the Alameda County Clerk-Recorder as an encumbrance of the title of the property identified above.

IN COUNCIL, OAKLAND, CALIFORNIA, _____, 20_____

PASSED BY THE FOLLOWING VOTE:

AYES - BROOKS, CAMPBELL WASHINGTON, GALLO, GUILLEN, KALB, KAPLAN, REID, and
PRESIDENT GIBSON MCELHANEY

NOES -

ABSENT -

ABSTENTION -

ATTEST: _____

LaTonda Simmons
City Clerk and Clerk of the Council
of the City of Oakland, California

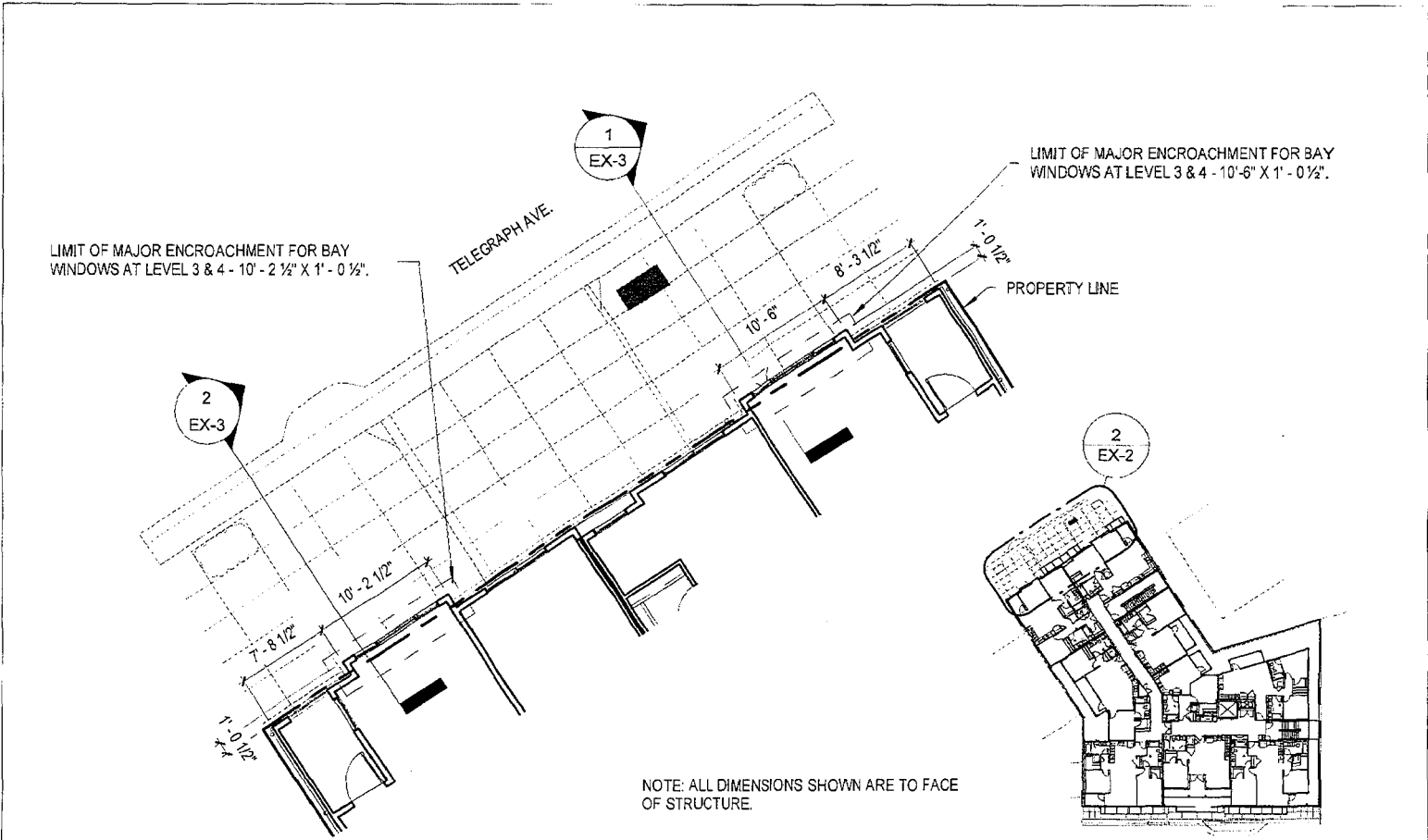

5239 CLAREMONT RESIDENTIAL

LEVEL 3 & 4

EX-2

Signature Development Group
 2335 Broadway, Suite 200
 Oakland, CA 94612

KTGY Group, Inc.
 Architecture+Planning
 580 Second St., Suite 200
 Oakland, CA 94607
 510.272.2910
 ktgy.com



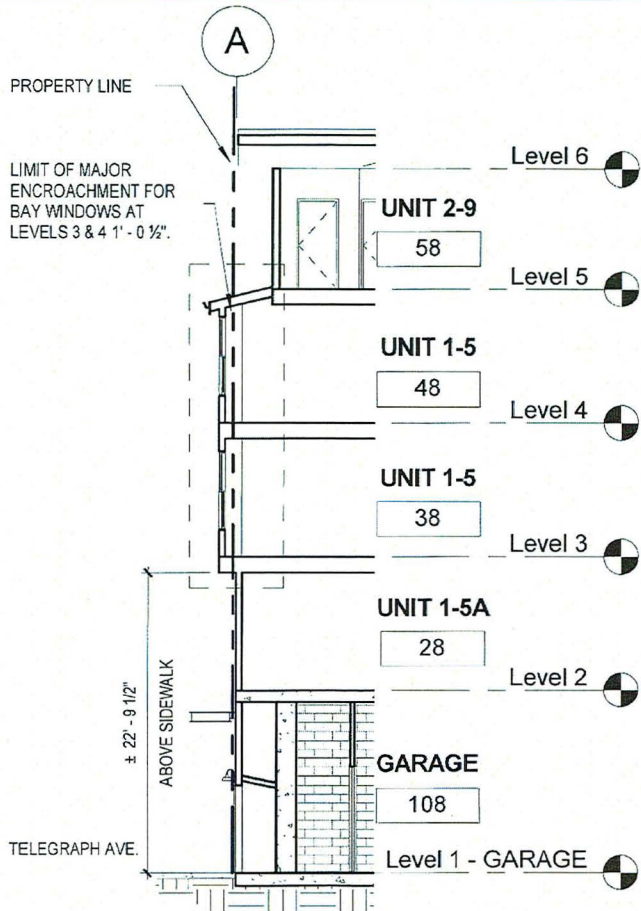

1

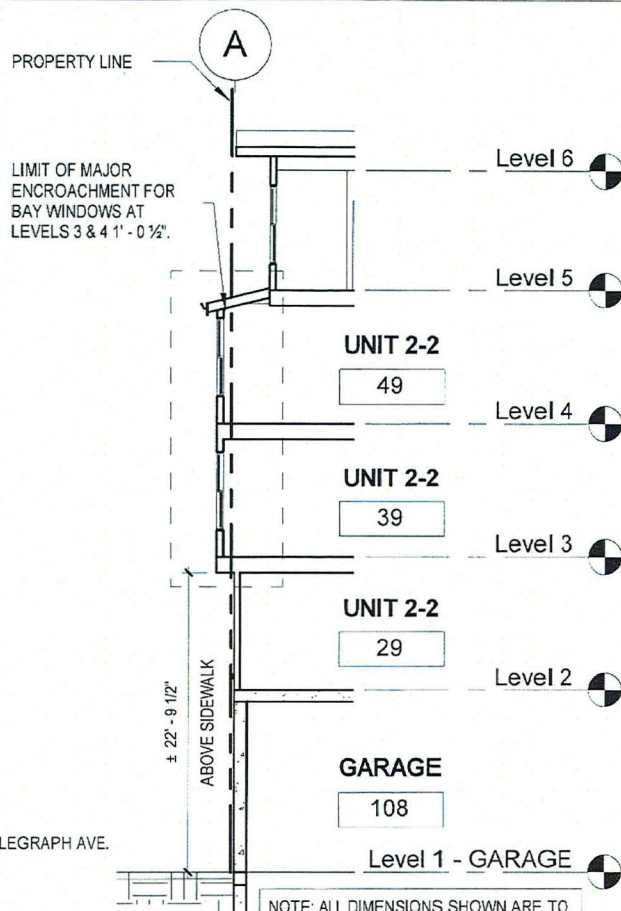

2

5239 CLAREMONT RESIDENTIAL

SECTION

EX-3

Signature Development Group
 2335 Broadway, Suite 200
 Oakland, CA 94612

KTGY Group, Inc.
 Architecture+Planning
 580 Second St., Suite 200
 Oakland, CA 94607
 510.272.2910
 ktgy.com

