

CITY OF OAKLAND

FILED  
OFFICE OF THE CITY CLERK  
OAKLAND

2018 MAY 31 PM 4: 32

# AGENDA REPORT

**TO:** Sabrina B. Landreth  
City Administrator

**FROM:** Ryan Russo  
Director, DOT

**SUBJECT:** Electric Vehicle Charging  
Encroachment Permits

**DATE:** May 21, 2018

City Administrator Approval

Date:

5/31/18

## RECOMMENDATION

Staff Recommends That The City Council Adopt The Following Resolutions:

1. **A Resolution Authorizing The City Administrator Or Her Designee To Negotiate, Finalize And Execute A Professional Services Agreement With EVgo For Installing And Operating Electric Vehicle Charging Stations At No Direct Cost To The City And Waiving The Request For Proposals/Qualifications ("RFP/Q") Requirement; and**
2. **A Resolution Granting A Conditional And Revocable Major Encroachment Permit To EVgo To Allow Portions Of Electric Vehicle Charging Stations At Lafayette Square To Encroach Into The Public Right-Of-Way Along 10<sup>th</sup> Street Near Jefferson Street; and**
3. **A Resolution Granting A Conditional And Revocable Major Encroachment Permit To EVgo To Allow Portions Of Electric Vehicle Charging Stations At Lake Park Parking Lot To Encroach Into The Public Right-Of-Way Along 533 Lake Park Avenue**

## EXECUTIVE SUMMARY

Approval of these resolutions will authorize the City Administrator or designee to enter into an agreement with and issue Major Encroachment Permits to EVgo, an electric vehicle company, at 610 10th Street (Lafayette Square) and 533 Lake Park Avenue (Lake Park Parking Lot). The encroachment permits require EVgo to comply with the conditions of the Site Agreement previously approved by the City Attorney and the pending indenture agreements. The encroachments would be along the curb and would not impact the use of the sidewalk nor obstruct the path of travel for pedestrians or persons with disabilities. Where appropriate, the encroachments would allow for a five-foot (5') unobstructed access to the public right of way. The encroachments are described in detail in the exhibits attached to the resolutions to the Major Encroachment Permits.

These resolutions will authorize EVgo to install a total of 10 electric vehicle (EV) charging stations at two demonstration locations across Oakland, at no direct cost to the City. **EVgo will compensate the City for any lost parking revenue.** At Lafayette Square, in western

Item: \_\_\_\_\_  
Public Works Committee  
June 12, 2018

downtown Oakland, EVgo has proposed installing an Equal Access Charging Hub (EACH) of four (4) EV charging ports. These ports will be the first "curbside" chargers in Oakland. The EACH is designed to serve three public EV parking spaces and two parking spaces dedicated for EV car sharing. At 533 Lake Park Avenue, in a City-owned parking lot, EVgo has proposed installing six EV charging ports. The Lake Park parking lot is centrally located in an area with one of the highest concentrations of multifamily buildings in the East Bay. The chargers at the Lake Park site are designed to serve five public EV parking spaces and two parking spaces dedicated for EV Car sharing.

Additionally, EVgo is committed to installing EV chargers at suitable sites in East Oakland. Staff is working with EVgo and key community partners to identify optimal locations for EV charging infrastructure in part of Oakland that has been historically underserved. The East Oakland sites currently under consideration include Foothill Square Shopping Center (10700 MacArthur Blvd. #200), and Eastmont Towne Center (7200 Bancroft Ave.). EVgo has also obtained initial approval to install a High Power Charging Station Plaza at FoodMaxx Fruitvale Station.

Together, these demonstration projects will enable the City to learn by doing and solve three key challenges of establishing widespread and equitable electric vehicle infrastructure: 1) providing EV charging at curbside in the public Right-of-Way (ROW), or "electrifying the curb"; 2) providing residents of multifamily buildings convenient and reliable access to EV infrastructure; and 3) providing EV charging to underserved communities. Current City policy does not provide guidance for curbside EV charging in the ROW; nor has the City identified a solution for cost effectively bringing convenient EV charging to existing multifamily buildings. Development of these proposals would prepare the City to identify solutions and appropriate regulatory tools based on real-world test cases. This pilot case will enable staff to determine necessary internal stakeholders; streamline coordination among the overlapping jurisdictions; analyze challenges associated with electrifying the curb and multifamily buildings; and begin simplifying procedures for permitting EV charging installations.

### **BACKGROUND / LEGISLATIVE HISTORY**

The Oakland Municipal Code (OMC) Chapter 12.08 requires a major encroachment permit for building elements encroaching into the public right-of-way as stated in the OMC Chapter 15.04.679 for revisions to the California Building Code (CBC) Section 3201.5.

#### *Policy Landscape of Electric Vehicles*

Vehicle electrification and development of associated electric vehicle (EV) charging infrastructure are the subject of state, regional, and local goals for climate action and air quality improvement. California Governor Jerry Brown has set state goals of placing 1.5 million zero-emission vehicles on California roads by 2025 and 5 million by 2030. In 2013, the Bay Area Air Quality Management District (BAAQMD) published a Bay Area Plug-in Electric Readiness Plan, which anticipates at least 246,900 EVs on Bay Area roads by 2025. In October 2017 Assembly Bill 1452 (Parking: Exclusive Electric Charging and Parking on Public Streets) enabled cities to enforce on-street EV charging. AB 1452 revised the California Vehicle Code (CVC) to authorize local jurisdictions to enforce regulations for active on-street EV charging. On Jan 26, 2018,

Governor Jerry Brown signed executive order B-48-18 setting a target of 250,000 vehicle charging stations in California by 2025. California currently has approximately 12,000 EV charging stations.

In 2012 Oakland City Council adopted an Energy and Climate Action Plan (ECAP) that committed the city to reduce its greenhouse gas (GHG) emissions 36 percent below 2005 levels by 2020 through multiple measures, including through vehicle efficiency and reduced vehicle miles traveled. ECAP Priority Action Item 37, "Plan for Electric Vehicle Infrastructure," includes developing new processes to support local use of electric vehicles. It also identifies processes to facilitate installation of EV infrastructure as a strategy to support the City's energy and climate goals. In February 2017, City Council adopted additional building codes requiring all new multifamily and non-residential buildings to be "PEV Ready" in excess of levels required by State code.

In May 2018 Oakland City Council adopted a new GHG emission target of 56% by 2030 based on the findings of the Oakland CURB Report.

### *EVgo*

In 2012 NRG Energy, Inc. (NRG) and the California Public Utilities Commission (CPUC) entered into a Long-Term Contract Settlement Agreement (NRG/CPUC Agreement) under which NRG will invest approximately \$100,000,000 over four years in electric vehicle charging infrastructure through its subsidiary, NRG EV Services LLC (DBA "EVgo"). On June 17, 2016, NRG closed the sale of a portion of its interest in EVgo to EV Holdings Investment, Inc., an investment vehicle of Vision Ridge Partners, LLC. NRG retains a significant minority investment in EVgo and will continue to execute its obligations under the NRG/CPUC Agreement through EVgo.

EVgo operates the largest public fast charging EV network in the nation, with more than 1,000 charging stations. EVgo has experience selecting and developing sites for chargers; managing large-scale build projects through permitting, construction, and operation; and maintaining a distributed network of chargers. EVgo has completed EV Charging projects on municipal properties with: Cities of Union City, San Mateo, San Carlos, St. Helena, Palm Springs, Palm Desert, Carlsbad, Huntington Beach, Monterey Park, Moreno Valley, and Hermosa Beach, and has projects under development with the City and County of San Francisco and the cities of Berkeley, Richmond, Sacramento, Burlingame, South San Francisco, and San Jose, among others.

As part of the NRG/CPUC Agreement, NRG will invest at least \$4,000,000 in projects that enhance appreciation of the social benefits of EVs and create opportunities for residents of underserved communities to benefit from expanded use of EVs in California (the "EV Opportunity Program"), which includes \$3,500,000 allocated specifically to Equal Access Charging Hubs (EACH). CPUC requires all charging hubs to be complete and operational no later than December 5, 2018.

### *EACH Hubs*

EVgo launched the EACH Project to create EV access and job opportunities to underserved communities. EACH aims to support EV car-sharing business models, create job opportunities, provide publicly available EV fast charging, and spur the adoption of EVs in underserved neighborhoods. EVgo plans to develop seven EACH sites in low-income communities of the San Francisco Bay Area, Los Angeles, and San Diego. DC fast charging, as opposed to level 1 or level 2 charging, is the quickest method for charging an electric vehicle where approximately 80 miles of range can be added in 30 minutes.

In the Bay Area, EVgo has partnered with carsharing company "Maven" to provide carsharing services at all EACH sites. Car share is a membership-based service available to all qualified drivers in a community, which allows members to make vehicle trips by operating a rented vehicle without a separate written agreement for each trip. Maven is a "Dedicated Space" EV car share model where vehicles are available 24/7 and members making round trips from a dedicated beginning and ending location. Members find the location of available vehicles in real-time using Maven's mobile application or website. Maven charges vehicle users according to how long they use the vehicles, inclusive of fuel, maintenance, insurance, and parking.

### **ANALYSIS AND POLICY ALTERNATIVES**

To meet statewide and municipal vehicle electrification targets, Oakland must efficiently scale the city's EV infrastructure. Approximately 12 percent of cars statewide must be EV's by 2025 to meet the California Air Resources Board (CARB) Zero-Emission Vehicle program target of 1.5 million zero-emission vehicles by 2025. While the state is slightly ahead of CARB's expected EV market share trajectory to that goal, EV infrastructure lags, and it remains largely concentrated in more affluent areas.

Oakland and other Bay Area communities have pledged to increase EV ownership. The Oakland ECAP notes that the City is to establish a regional hub for EV ownership, and identifies EV infrastructure expansion as a strategy to support the City's energy and climate goals. Supporting EV charging was also identified as a top priority action in Oakland's recently completed CURB report. CURB was developed by the World Bank, C40, Bloomberg Philanthropies, and the Global Covenant of Mayors to assist cities in evaluating the most cost-effective methods to reduce GHG emissions and creating climate action plans. The CURB Final Report identified the most cost-effective and impactful areas of focus for reducing GHG emissions; "accelerate electrification of vehicles" was one of five actions projected to have an outsized impact in reducing the City's GHG emissions.

To assist in meeting these targets, EVgo has offered to fully fund, design, and construct EV chargers in at least two, and as many as four or more, locations across Oakland (**see Table 1 on page 7**). EVgo has demonstrated the technical and professional capability to address these challenges in their collaboration with Staff to date.

Staff, working with EVgo, selected three project sites that would demonstrate scalable solutions to critical challenges that Oakland faces in developing EV charging infrastructure: 1) "electrifying

the curb”; 2) providing access to EV charging in multifamily buildings; and 3) equitable distribution of EV charging infrastructure across the city. These demonstration projects will prepare Oakland to efficiently scale and equitably develop the City’s EV infrastructure.

*Electrifying the Curb: Lafayette Park*

EVgo has proposed installing an EACH hub at Lafayette Square in western downtown Oakland. This site would include four EV charging ports, serving three public EV parking spaces and two parking spaces dedicated to EV carsharing. EVgo has partnered with Maven to own and operate the car share vehicles at this location. This EACH hub would pilot the first “curbside” chargers in Oakland. Electrifying the curb at this location is a first step to expanding permit processes to accommodate curbside charging city-wide.

Installations of curbside EV charging stations face multiple challenges:

- **Overlapping Jurisdictions:** In any given EV charging project, several departments may need to be involved, including Parks and Recreation, Planning and Building, Public Works, Department of Transportation, and the City Attorney’s Office. In addition to these departments, coordination could likely include PG&E, private property owners, and community stakeholders.
- **Conveying Electricity to the Curb:** Physically running electricity from a nearby power source to the chargers often requires trenching and moving concrete, burying electrical lines, and siting new transformers and other electrical equipment. However, “the curb” is a public right of way that must remain unobstructed by any electrical equipment for safety and mobility priorities.
- **Parking Equipment:** Co-location of equipment or systems to process both parking fees and payments for electric vehicle charging may be a challenge for allocating space, reducing customer confusion, and encouraging use of the charging stations.
- **Enforcement:** The City must devise policies and practices for enforcing new requirements to ensure that only electric vehicles use the spaces dedicated for vehicle charging; that cars move once they are fully charged; and that charging equipment is maintained in acceptable working order a minimum percentage of the year (i.e., a minimum “up-time”).

Current City policy does not provide guidance for curbside EV charging in the public right-of-way (PROW). This project would let the City identify solutions and appropriate regulatory tools based on a real-world test case, at no direct cost the City, to address these challenges. A pilot case will enable staff to determine necessary internal stakeholders; streamline coordination among jurisdictions; analyze the challenges of conveying electricity to the curb; and begin simplifying procedures for permitting EV charging in the PROW. It will also enable staff to develop appropriate regulations and guidance, and explore related issues for on-street DC fast charging infrastructure at other locations. Siting curbside charging in the PROW will necessitate policies yet to be developed regarding Americans with Disabilities Act (ADA) accessibility standards, safety, siting of electrical equipment, parking enforcement, and consideration of metered parking. Staff is exploring necessary updates to create and enforce on-street EV parking regulations per Assembly Bill (AB) 1452.

Item: \_\_\_\_\_  
Public Works Committee  
June 12, 2018

Standard DC Fast EV charging technologies typically provide 80 miles of range in 30 minutes of charging, with unique considerations for on-street parking. Curbside DC fast charging offers several benefits:

- More rapid charging and higher vehicle turnover;
- Avoiding potential conflicts with time restrictions for on-street parking;
- Increased visibility and convenience, supporting a broader user base; and
- A stronger message of City leadership and public support for EV technologies.

To provide EV charging at this site, an encroachment permit is required. The encroachment permit to be issued to EVgo allows for four proposed DC electric vehicle (EV) chargers along 10th Street at Lafayette Square. Each of the four chargers will encroach into the public right of way with an approximate three-feet six-inches (3'6") by three-feet (3') footprint for a total encroachment of 33 sq. ft. The meter pedestal electrical support equipment will be installed on a concrete pad northeast of the charging stations and out of the public right of way. The meter pedestal has dimensions of two-feet three-inches (2'3") long, by three-feet six-inches (3'6") wide, by five-feet four inches (5'4") tall. The meter pedestal's concrete footprint has dimensions of eight feet (8'3") by four-feet (4'). The chargers will be connected to one another and the electrical equipment bored/trenched electrical line. Details of the proposed 10th Street encroachment is shown in **Exhibit A to the Lafayette Square Resolution**.

#### *EV Charging for Multifamily Buildings: Lake Park*

Oakland's stock of multifamily buildings is substantial. In 2013, approximately 33 percent of the City's housing stock was in multifamily buildings with five or more units, and 19 percent was in buildings of two to four units.<sup>1</sup> Existing apartment buildings are one of the most challenging building types in which to install EV charging infrastructure. Numerous barriers discourage retrofitting to accommodate EV infrastructure, the greatest of which is cost. There is also a disconnect between tenants who may be required to pay for the installation, and the building owners who own the infrastructure once it is installed. Finally, landlords and homeowners' associations often set insurance requirements or other conditions that discourage retrofit of EV infrastructure by tenants or condo owners. Enabling access to convenient and fast EV charging near existing multifamily buildings offers a path to circumventing these barriers entirely.

Because so many Oaklanders live in apartment buildings, solving the problem of how to get convenient access to EV charging to renters is an important priority for the City. A fast, centrally located charging hub is a promising solution, as it would most closely mirror a gas station's "fill-and-go" experience.

The EV charging project at Lake Park would constitute a "High-Speed EV Charging Plaza" (Plaza). Lake Park is centrally located in an area with one of the highest concentrations of multifamily buildings the East Bay. At this site, EVgo would expand the City's EV charging services with new, advanced high-power DC fast charger technology in a highly visible location.

---

<sup>1</sup> City of Oakland Housing Element 2015-2023

The new chargers would be 150-kilowatt (kW) high-power DC fast chargers, a new generation of technology that can provide a up to a 300-mile range in as little as 20 to 30 minutes.

To provide EV charging at this site an encroachment permit is required. The encroachment permit to be issued to EVgo allows for six proposed 150kW EV chargers along 533 Lake Park Avenue to encroach into the public right of way with an approximate two-feet six-inch (2'6") by three-feet six-inch (3'6") footprint for a total encroachment of 54ft<sup>2</sup>. Electrical support equipment including electrical cabinets, distribution equipment, and switchgear will need be installed in a fenced in enclosure approximate 45 feet south of the charging stations in unutilized space between two highway support columns. The footprint of the electrical support equipment will be approximately 15 ft<sup>2</sup> by 10'6". The chargers will be connected to one other and the electrical equipment bored/trenched electrical lines. Lastly, an existing bike rack with be relocated on site to accommodate a new utility transformer with a footprint of approximately eight-feet by eight-feet. Details of the proposed Lake Park Avenue encroachment is shown in **Exhibit A to the Lake Park Avenue Major Encroachment Resolution**.

**Summary of EV Charging Locations**

	<i>Lafayette square</i>	<i>Lake Park</i>	<i>East Oakland</i>
Address	610 10th St.	533 Lake Park Ave.	TBD
City Owned & Operated	No	No	No
Equal Access Charging Hub	✓		TBD
High Power Plaza		✓	TBD
Total Number of Parking Spaces	5	7	TBD
Spaces reserved for Carshare	2	2	TBD
Number of Ports	4	6	TBD
Estimated Fees Paid Annually to City*	\$7,500	\$10,500	N/A

Table 1

\* Assuming average annual meter revenue of \$1,500.00 per parking space.

*Equity in EV Charging: East Oakland Investments*

Electric vehicles can be a powerful tool for social equity. EV's reduce pollution associated with private automobile use, and reduce lifetime driving expenses through reduced fueling and maintenance costs. Moreover, the "secondary market" of used EV's is growing rapidly. This market will make EV purchases much more accessible to lower-income residents; if publicly-accessible fast charging infrastructure is available, more Oaklanders will consider purchasing EV's, both new and used.

As such, EV amenities are needed in East Oakland. Disadvantaged communities tend to have less access to EV charging due to a higher likelihood of living in older and/or multifamily

Item: \_\_\_\_\_  
 Public Works Committee  
 June 12, 2018

buildings. Investment in public EV infrastructure in East Oakland has also been limited to date. Facilitating EV charging infrastructure in East Oakland will in turn facilitate EV ownership and use among those whose only barrier to purchasing or leasing an EV is the lack of convenient charging.

Staff is working with EVgo and key community partners in the retail and nonprofit sectors to identify optimal locations for EV charging infrastructure in parts of Oakland that have been underserved. EVgo has pledged to install EV chargers in East Oakland and is currently working with Staff to identify installation sites. The sites currently under consideration include FoodMaxx Fruitvale Station (3000 E 9th St.), Allen Temple Baptist Church (8501 International Blvd), Foothill Square Shopping Center (10700 MacArthur Blvd.), and Eastmont Towne Center (7200 Bancroft Ave.). A High Power Charging Station Plaza at the FoodMaxx site has received initial approval. EV charger installations at these sites will address key EV equity needs whose solutions have been elusive to date. This agreement provides the City an opportunity to analyze methods, develop a priority siting list, and build relationships for future installations of EV infrastructure in hard to reach and low-income communities. This will allow for an equitable expansion of community EV infrastructure with state-of-the-art charging technology, at no direct cost to the City. In addition to the locations listed here, EVgo is prospecting additional sites in Oakland for EVgo Charging Stations in 2019 and beyond.

#### *Demonstration of Scalable EV Infrastructure Projects*

These demonstration projects will enable the City to leverage private investment to further state, regional, and City targets for EV adoption and development of EV infrastructure. These projects advance Oakland's climate and transportation modernization goals by planning for and developing new EV infrastructure and developing new processes to adopt and support local use of EVs. These efforts are consistent with adopted goals to support zero-emission vehicles and test new ways to provide services. The projects allow the City to prepare for potential near-term investment in EV programs and will equip the City to move quickly and effectively for any future EV investments in the community. Furthermore, these demonstration projects enable the City to learn-by-doing and solve the challenges of 1) "electrifying the curb", 2) providing residents of multifamily buildings access to EV infrastructure, and 3) providing EV charging to underserved communities.

To ensure these charging stations are assessable to all EV drivers, all charging equipment will be universally compatible for both CHAdeMO and CCS standards. The chargers will be accessible to both EVgo subscribers and non-subscribing customers. The 150-kW chargers will offer "backwards" fast charging compatibility for EVs with smaller batteries that are unable to charge at the full 150-kW level. To proceed with installation of these chargers two encroachment permits are needed.

#### *Encroachment Permit Description*

The proposed encroachments consist of above ground electrical equipment and below ground electrical lines. The projects will comply with the conditions of the encroachment permits as detailed in the authorizing resolutions and pending approval by the Planning and Building Department. The aboveground equipment will be placed as to not interfere with public use of the

Item: \_\_\_\_\_  
Public Works Committee  
June 12, 2018



right-of-way and the buried electrical lines. The encroachments will not obstruct the sidewalk and have no impact on public welfare and convenience. The projects will provide at least five-foot (5') six-inches (6") of clear path of travel for pedestrians and persons with disabilities.

Approval of these two Major Encroachment permits will allow the City to execute an indenture agreement with EVgo to hold them liable and responsible for private improvements in the public right-of-way. The agreement will allow the City to revoke the permits if necessary and require EVgo to remove the encroachments and restore the public right-of-way if necessary.

Oakland Municipal Code (CMC) Section 2.04.050 requires formal advertising and competitive bidding when the City purchases services, supplies or combination thereof required by the City which exceeds \$50,000.00. However, OMC Section 2.04.050 I. 5 permits the Council to waive these requirements upon a finding and determination that it is in the best interests of the City to do so. Additionally, OMC Section 2.04.051 A requires the City to conduct an RFP/Q prior to the purchase of professional services unless this requirement is waived under OMC Section 2.04.051B upon a finding by the City Council or its designee that it is in the best interests of the City to do so.

Staff recommends that, based on the reasons and circumstances set forth above, the Council pursuant to OMC Section 2.04.50 1.5 and Section 2.04.051 B, respectively, finds and determines that it is in the best interests of the City to waive the formal advertising, competitive bidding, and the RFP/Q requirements and authorize the City Administrator, or her designee, to negotiate and enter into an agreement with EVgo.

### **FISCAL IMPACT**

There is no direct cost to the City for the proposed pilot sites. Staff costs for processing the proposed encroachment permits are covered by fees set by the Master Fee Schedule and have been paid by the applicant. EVgo will compensate the City dedicated use of metered parking spaces for EV charging purposes, offsetting revenues that would have been generated from general metered parking. Rates of compensation will be determined in the Agreement using terms and conditions drawn from the Dedicated-Space Carshare fees set by the Master Fee Schedule. Ongoing maintenance, operation, networking, and electrical costs will be solely incurred and paid by EVgo. Staff resources across several departments, but especially in the Departments of Public Works and Transportation, were needed for this project. Ongoing efforts to support electrification will require dedicated resources. Those requirements will be the subject of a future report and recommended actions.

### **PUBLIC OUTREACH / INTEREST**

These projects do not require public outreach other than posting on the City's website. However, Staff conducted outreach to community groups and stakeholders that could have an interest in the development of the Lake Park location. Outreach was done through information sheets placed at the weekend farmers market and comments were collected through a dedicated email account.

Item: \_\_\_\_\_  
Public Works Committee  
June 12, 2018

Both EVgo and City staff have conducted outreach to potential partners and site hosts across East Oakland in searching for appropriate sites.

Once installed, the City will market these EV charging hubs through numerous channels including the Sustainable Oakland webpage, the Sustainable Oakland Facebook page, the City Administrator's Weekly Report, among others.

### **COORDINATION**

The permit application was coordinated with Planning and Building Department, Public Works Environmental Services Division Sustainability Team, Transportation Right of Way Management and Parking and Mobility Divisions, and Office of the City Attorney. Site planning was coordinated with the Department of Parks and Recreation and Transportation Americans With Disabilities Administration (ADA) Programs Division. General coordination was completed with the Budget Bureau and the Office of the City Attorney.

### **SUSTAINABLE OPPORTUNITIES**

**Economic:** This measure is expected to provide local economic benefits. Direct benefits include local construction jobs to provide and maintain EV infrastructure and reduce retrofit costs for building owners. In addition, local businesses and residents can realize the economic benefits from transitioning to EVs due to the lower costs of operating their vehicles. Consumer cost savings from avoided petroleum purchases will likely increase the number of dollars that are retained within the local economy. EV owners are more likely to purchase rooftop solar power or add capacity, providing another potential source of local construction employment. Finally, convenient access to the carshare located at the EACH hubs will provide Oaklanders an economical option for electrified transportation without requiring the large upfront expense associated with purchasing an EV or the lifetime costs personal vehicle ownership. Studies have also shown that carsharing can relieve parking and traffic congestion.

**Environmental:** Enabling construction of EV infrastructure directly aligns with the City's commitment to develop EV infrastructure as outlined in the ECAP. Environmental benefits are derived from reduced GHG emissions associated with driving EVs. Each EV displaces an average of 2.6 tons per year of GHG emissions if powered by conventional electricity, and more if powered by renewable electricity.<sup>2</sup> EVs will also reduce local impacts of air pollutants such as ozone and fine particulates. These benefits will improve local health outcomes. Combining EVs with carshare has the potential to magnify these environmental benefits. Research has shown that for each car sharing vehicle added to a neighborhood results in 9-13 private vehicles either shed or avoided.<sup>3</sup> Car share vehicles also tend to have better fuel economy than the average

---

<sup>2</sup> "Plug-In Electric Vehicle Infrastructure Cost-Effectiveness Report" July 20, 2016. Prepared by E. Pike and J. Steuben, Energy Solutions, for the City of Oakland.

<sup>3</sup> "The Impact of Carsharing on Household Vehicle Ownership". Spring 2011. Elliot Martin and Susan Shaheen Access, 38 22-27

privately-owned vehicle, and have been shown to reduce GHG emissions and increase rates of walking and cycling.

**Social Equity:** This project will enhance social equity by making EV infrastructure more plentiful and equitably distributed throughout the city. Lack of convenient charging infrastructure is a primary barrier for many people who would otherwise own electric vehicles. A majority of EV drivers charge their cars at home,<sup>4</sup> but home charging is generally not an option for individuals living in multifamily buildings or older homes. Installing EVSE in existing multifamily buildings is often cost-prohibitive and remains a barrier to advancing convenient fast charging within communities that need them the most. Enabling all Oaklanders, regardless of income or housing status, to have plentiful access to EV infrastructure will ensure that EV ownership is more attainable. As described above, EVs reduce air pollution and are generally more cost-effective over the lifetime of the vehicle as compared to conventional vehicles. Expanding access to EVs to lower-income and disadvantaged members of the community can reduce the health impacts related to air pollution disproportionately experienced by vulnerable populations and increase the income security of low income populations. Lastly, siting a dedicated space carshare on the edge of Old Oakland and near West Oakland enables that community to benefit the most from the amenity. The EACH hub project will demonstrate that the City is taking steps to expand car sharing services to underrepresented neighborhoods and areas currently poorly served by car sharing.

### **CALIFORNIA ENVIRONMENTAL QUALITY ACT**

The California Environmental Quality Act ("CEQA") and the CEQA Guidelines exempt specific types of projects from environmental review. The following CEQA exemptions apply to this encroachment under CEQA, 15183. (projects consistent with a Community Plan, General Plan, or Zoning), and 15061(b)(3) (no significant effect on the environment).

### **ACTION REQUESTED OF THE CITY COUNCIL**

Staff recommends that the City Council adopt resolutions:

1. Authorizing The City Administrator Or Her Designee To Negotiate, Finalize And Execute A Professional Services Agreement With EVgo For Installing And Operating Electric Vehicle Charging Stations At No Direct Cost To The City And Waiving The Request For Proposals/Qualifications ("RFP/Q") Requirement
2. Granting A Conditional And Revocable Major Encroachment Permit To EVgo To Allow Portions Of Electric Vehicle Charging Stations At Lafayette Square To Encroach Into The Public Right-Of-Way Along 10<sup>th</sup> Street Near Jefferson Street

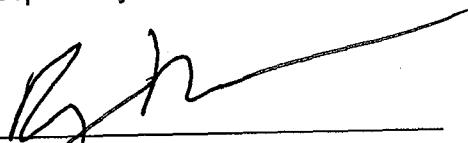
---

<sup>4</sup> U.S. Department of Energy. EV Everywhere Workplace Charging Challenge, 2014 Progress Report [http://energy.gov/sites/prod/files/2014/11/f19/progress\\_report\\_final.pdf](http://energy.gov/sites/prod/files/2014/11/f19/progress_report_final.pdf)

3. Granting A Conditional And Revocable Major Encroachment Permit To EVgo To Allow Portions Of Electric Vehicle Charging Stations at Lake Park Parking Lot To Encroach Into The Public Right-Of-Way Along 533 Lake Park Avenue

For questions regarding this report, please contact Michael Ford, Parking and Mobility Programs Manager, at (510) 238-7670.

Respectfully submitted,



---

RYAN RUSSO  
Director, Department of Transportation

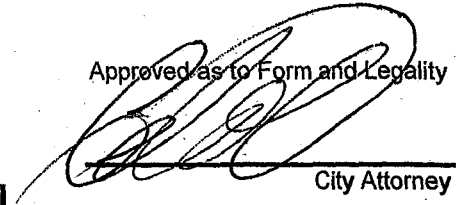
Reviewed by:  
Wladimir Wlassowsky, RE., Assistant Director,  
Department of Transportation

Prepared by:  
Michael Ford, Acting Manager, Parking and  
Mobility Division

Item: \_\_\_\_\_  
Public Works Committee  
June 12, 2018

2018 MAY 31 PM 4:33

Approved as to Form and Legality



City Attorney

# OAKLAND CITY COUNCIL

**RESOLUTION No. \_\_\_\_\_ C.M.S.**

Introduced by Councilmember \_\_\_\_\_

---

**RESOLUTION AUTHORIZING THE CITY ADMINISTRATOR OR HER DESIGNEE TO NEGOTIATE, FINALIZE, AND EXECUTE A PROFESSIONAL SERVICES AGREEMENT WITH EVGO FOR INSTALLING ELECTRIC VEHICLE CHARGING STATIONS AT NO DIRECT COST TO THE CITY AND WAIVING THE REQUEST FOR PROPOSALS/ QUALIFICATIONS ("RFP/Q") REQUIREMENT**

**WHEREAS**, the City Council adopted the Energy and Climate Action Plan in December 2012 to identify and prioritize actions that Oakland can take to reduce its energy consumption and greenhouse gas (GHG) emissions by 36% reduction relative to 2005 levels, including engaging in plug-in electric vehicle (PEV) infrastructure planning and development; and

**WHEREAS**, potential PEV users in Oakland may be discouraged from buying PEVs due to the unavailability of PEV Charging stations; and

**WHEREAS**, California has set state goals of placing 1.5 million zero-emission vehicles on California roads by 2025 and 5 million by 2030; and

**WHEREAS**, On Jan 26, 2018, Governor Jerry Brown signed executive order B-48-18, setting a target of 250,000 PEV charging stations in California by 2025; and

**WHEREAS**, EVgo is a reputable PEV charging company that operates the largest public fast charging EV network in the nation, with more than 1,000 charging stations; and

**WHEREAS**, EVgo entered into a Long-Term Contract Settlement Agreement with the California Public Utilities Commission to invest approximately \$100,000,000 over four years in electric vehicle charging infrastructure throughout the State; and

**WHEREAS**, EVgo has the expertise and desire to install PEV charging stations at two locations in Oakland where staff have agreed that such infrastructure would accomplish significant climate and social benefits, namely, providing convenient and accessible PEV charging to a large population of multifamily building dwellers, demonstrating a new approach to conveying electricity to a public curb for PEV charging, and providing public curbside charging for electric car share vehicles; and

**WHEREAS**, staff has determined, based on review of the plans and investigation of the two sites, that the projects will not interfere with public use of the roadway, sidewalk, or buried utilities, and will not endanger the public welfare and convenience; and

**WHEREAS**, staff has determined, based on consultation with EVgo, that one or more project sites under the agreement will involve the suspension or removal of parking meters; and

**WHEREAS**, each as a separate and independent basis, this action is exempt from the California Environmental Quality Act ("CEQA") pursuant to CEQA Guidelines sections 15301 (existing facilities), 15183 (projects consistent with General Plan and Zoning), and 15061(b)(3) (no significant effect on the environment); and

**WHEREAS**, Oakland Municipal Code (O.M.C.) § 2.04.051.A. requires staff to conduct a competitive RFP/Q competitive selection process for professional services; and

**WHEREAS**, O.M.C. § 2.04.051.B permits the City Council to waive such RFP/Q requirement upon a finding that it is in the best interest of the City to do so; and

**WHEREAS**, staff believes that it is in the best interest of the City for the City Council to waive the RFP/Q requirement in this instance because EVgo, a highly reputable EV charging company, is providing a free service that will advance the City's transportation and climate goals and would otherwise cost the City approximately \$1.3 million to execute; now, therefore be it

**RESOLVED:** That the City Council finds and determines that, pursuant to O.M.C. § 2.04.051A and for the reasons stated above and in the accompanying report, it is in the best interests of the City to waive the competitive RFP/Q competitive selection requirement of the O.M.C. for the award of a professional services agreement to the Energy Solutions, and so waives the requirements; and be it

**FURTHER RESOLVED:** That the City Administrator, or her designee, is hereby authorized to execute a professional services agreement with EVgo for the installation, operation, maintenance and, if necessary, removal of its electric vehicle charging stations at no direct cost to the City at 610 10th Street (Lafayette Park) and 533 Lake Park Avenue; and be it

**FURTHER RESOLVED:** That such agreement obligate EVgo to compensate the City for lost parking revenues; and

**FURTHER RESOLVED:** That the agreement is subject to City Attorney review and approval for form and legality and a copy of this resolution shall be filed with the City Clerk without returning to Council.

IN COUNCIL, OAKLAND, CALIFORNIA, \_\_\_\_\_

**PASSED BY THE FOLLOWING VOTE:**

AYES - BROOKS, CAMPBELL WASHINGTON, GALLO, GUILLEN, KALB, KAPLAN, REID, AND  
PRESIDENT GIBSON MCELHANEY

NOES -

ABSENT -

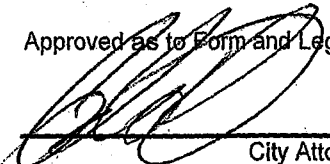
ABSTENTION -

ATTEST: \_\_\_\_\_  
LaTonda Simmons  
City Clerk and Clerk of the Council  
of the City of Oakland, California

2018 MAY 31 PM 4: 33

Approved as to Form and Legality

# OAKLAND CITY COUNCIL

  
City Attorney

**RESOLUTION No. \_\_\_\_\_ C.M.S.**

Introduced by Councilmember \_\_\_\_\_

---

**RESOLUTION GRANTING A CONDITIONAL AND REVOCABLE MAJOR ENCROACHMENT PERMIT TO EVGO TO ALLOW PORTIONS OF ELECTRIC VEHICLE CHARGING STATIONS AT LAFAYETTE SQUARE TO ENCROACH INTO THE PUBLIC RIGHT-OF-WAY ALONG 10TH STREET NEAR JEFFERSON STREET**

**WHEREAS**, EVgo (“Applicant”), a reputable plug-in electric vehicle (PEV) charging company that operates the largest public fast charging EV network in the nation with more than 1,000 charging stations, plans to install PEV charging stations at real property owned by the City Of Oakland and described in a Grant Deed Recorded November 20, 2017 by the Alameda County Clerk-Recorder and identified by the Alameda County Assessor as APN: 002-0025-001-00 and commonly known as **Lafayette Square** hereto and incorporated herein, plans to file an application with the Department of Transportation for a Conditional and Revocable Encroachment Permit to allow portions of electric vehicle charging stations to encroach into the public right-of way on 10<sup>th</sup> Street near Jefferson at Lafayette Square; and

**WHEREAS**, the renderings limits of the encroachments are delineated in Exhibit A hereto and Incorporated herein; and

**WHEREAS**, the Applicant will apply for and secure Major Encroachment permit with the Department of Transportation for a conditional and revocable major encroachment for vehicle charging equipment to encroach into the public right of way. In addition, the applicant will prepare a complete Civil Engineering drawing for a permit (PX permit) with the department of transportation for any required improvement needed to public facilities including curb, gutter, sidewalk, roadway, and accessible ramps and access points. In addition, the applicant will apply for and secure Obstruction Permit(s) (OB permit) and excavation permit(s) (X permit) that may be needed for a complete installation of a fully functional vehicle charging station. Moreover, the applicant will apply for and secure utility permit from utility companies and building permits and electrical permits from the Building Departments that may be needed for a fully functioning electrical charging station; and

**WHEREAS**, staff has determined, based on review of the preliminary plans and investigation of the site of the encroachments, said encroachments in the public right-of-way and their location



will not interfere with public use of the roadway, sidewalk, buried utilities, and will not endanger the public welfare and convenience during said public use; and

**WHEREAS**, each as a separate and independent basis, this action is exempt from the California Environmental Quality Act ("CEQA") pursuant to CEQA Guidelines sections 15301 (existing facilities), 15183 (projects consistent with General Plan and Zoning), and 15061(b)(3) (no significant effect on the environment); and

**WHEREAS**, a bond or securities in the amount no less than the full value of the work as verified by the City Engineer be submitted to the City and/or secured in a manner satisfactory to the City for the City to return the area to its original or better conditions should the Applicant fail to perform its obligation under the Major Encroachment to keep the installation free from graffiti and in good functioning conditions or to remove the improvements upon revocation of the Major Encroachment by the City Council. The bond shall be maintained for the life of the encroachment; therefore be it

**RESOLVED:** That the City Council has reviewed all relevant documents relating to its grant of the encroachment permits that is the subject of this resolution; and be it

**FURTHER RESOLVED:** That the City Council finds and determines that the decision made hereby is made in conformance with the requirements of CEQA; and be it

**FURTHER RESOLVED:** That upon the satisfactory completion of the required work and close-out of construction permits, and upon testing and acceptance of all equipment, and upon posting of the bond for the life of the asset by the Applicant and upon the approval of the Major Encroachment permit by the Department of Transportation Director, the "Applicant" will be then considered a "Permittee"; and be it

**FURTHER RESOLVED:** That said major encroachment permits are hereby conditioned by the following special requirements:

1. This agreement may be voided and the associated permits for encroachments may be revoked at any time and for reasons including but not limited to preservation of public safety or failure on the part of the Permittee to maintain improvements, at the sole discretion of the City Council, expressed by resolution as being in the City's best interest, or the associated permit may be suspended at any time, at the sole discretion of the City Engineer, upon failure of the Permittee to comply fully and continuously with each and all of the conditions set forth herein and in the associated permits;
2. The Permittee hereby disclaims any right, title, or interest in or to any portion of the public right of way, including the sidewalk and street, and agrees that the encroachments are granted for an indeterminate period of time and that the use and occupancy by the Permittee of the public right of way is temporary and does not constitute an abandonment, whether expressed or implied, by the City of Oakland of any of its rights associated with the statutory and customary purpose and use of and operations in the public right-of-way;

3. The Permittee shall maintain fully in force and effect, at its own expense, at all times during the period for which the permit is in effect, good and sufficient public liability insurance and property damage insurance, both including contractual liability, insuring the City of Oakland, its officers, agents, employees, and volunteers against any and all claims arising out of the existence of the encroachments in the public right-of-way, as respects liabilities assumed under this permit, in amounts for each occurrence as determined and approved by the City's Risk Manager. The policy shall contain an endorsement declaring the policy as primary coverage on said liabilities. The Permittee shall submit a written certificate of such insurance or copy of the policy to City Engineer showing that insurance is in effect in compliance with this section, and shall file subsequent notices of the renewal thereof with the City Engineer. Such certificate shall state that the insurance coverage shall not be canceled, amended or be permitted to lapse without thirty (30) days prior written notice to City Engineer. The Permittee also agrees that the City Engineer, at his or her sole discretion, may review the type and amount of insurance required of the Permittee annually and may require the Permittee to increase the amount of and/or change the type of insurance coverage required, within reason and as circumstances warrant;
4. The Permittee shall be solely and fully liable and responsible for the repair, replacement, removal, reconstruction, and maintenance of any portion or all of the private improvements constructed or installed in the public right-of-way, whether by cause, neglect, or negligence of the Permittee or others, and for the associated costs and expenses necessary to restore or remove the encroachments to the satisfaction of the City Engineer, and shall not allow the encroachments to become a blight or a menace or a hazard to the health and safety of the general public;
5. The Permittee acknowledges and agrees that the encroachments are out of the ordinary and does not comply with City of Oakland standard installations. The Permittee further acknowledges and agrees that the City of Oakland and public utility agencies will periodically conduct work in the public right-of-way, including excavation, trenching, and relocation of its facilities, all of which may damage the encroachments. The Permittee further acknowledges and agrees that the City and public utility agencies take no responsibility for repair or replacement of the encroachments which may be damaged by the City or its contractors or public utility agencies or their contractors. The Permittee further acknowledges and agrees that upon notification by and to the satisfaction of the City Engineer, Permittee shall immediately repair, replace, or remove, at the sole expense of the Permittee, all damages to the encroachments that are directly or indirectly attributable to work by the City or its contractors or public utility agencies or their contractors. Notwithstanding the foregoing, this section may be subject to mutually agreed upon limitations;
6. The Permittee shall remain liable for and shall immediately reimburse the City of Oakland for all costs, fee assessments, penalties, and accruing interest associated with the City's notification and subsequent abatement action for required maintenance, repairs, or removal, whether in whole or in part, of the encroachments or of damaged City infrastructure made necessary by the failure, whether direct or indirect, of the Permittee to monitor the

encroachments effectively and accomplish preventative, remedial, or restorative work expeditiously. The City reserves the unqualified right to collect all monies unpaid through any combination of available statutory remedies, including recordation of Prospective Liens and Priority Liens/ Special Assessments with the Alameda County Recorder, inclusion of non-reimbursed amounts by the Alameda County Assessor with the annual assessment of the general levy, and awards of judgments by a court of competent jurisdiction;

7. Upon revocation of the either encroachment permit, the Permittee shall immediately, completely, and permanently remove the encroachment from the public right-of-way, repair any damage resulting therefrom, and restore the public right-of-way to its original conditions existing before the construction or installation of the encroachment, to the satisfaction of the City Engineer and all at the sole expense of the Permittee;
8. This agreement and the associated permits for the encroachments shall become effective upon filing of this agreement with the Alameda County Recorder for recordation as an encumbrance of the property and its title;
9. The Permittee acknowledges that the City makes no representations or warranties as to the conditions beneath said encroachment. By accepting this revocable permit. Permittee agrees that it will use the encroachment areas at its own risk, is responsible for the proper coordination of its activities with all other permittees, underground utilities, contractors, or workmen operating, within the encroachment areas and for the safety of itself and any of its personnel in connection with its entry under this revocable permit;
10. The Permittee acknowledges that the City is unaware of the existence of any hazardous substances in either encroachment areas, and Permittee hereby waives and fully releases and forever discharges the City and its officers, directors, employees, agents, servants, representatives, assigns and successors from any and all claims, demands, liabilities, damages, actions, causes of action, penalties, fines, liens, judgments, costs, or expenses whatsoever (including, without limitation, attorneys' fees and costs), whether direct or indirect, known or unknown, foreseen or unforeseen, that may arise out of or in any way connected with the physical condition or required remediation of the excavation area or any law or regulation applicable thereto, including, without limitation, the Comprehensive Environmental Response, Compensation and Liability Act of 1980, as amended (42 U.S.C. Sections 9601 et seq.), the Resource Conservation and Recovery Act of 1976 (42 U.S.C. Section 466 et seq.), the Safe Drinking Water Act (14 U.S.C. Sections 1401,1450), the Hazardous Waste Control Law (California Health and Safety Code Sections 25100 et seq.), the Porter-Cologne Water Quality Control Act (California Health and Safety Code Section 13000 et seq.), the Hazardous Substance Account Act (California Health and Safety Code Sections 253000 et seq.), and the Safe Drinking Water and Toxic Enforcement Act (California Health and Safety Code Section 25249.5 et seq.);
11. The Permittee further acknowledges that it understands and agrees that it hereby expressly waives all rights and benefits which it now has or in the future may have, under and by virtue of the terms of California Civil Code Section 1542, which reads as follows: "A GENERAL

RELEASE DOES NOT EXTEND TO CLAIMS WHICH THE CREDITOR DOES NOT KNOW OR SUSPECT TO EXIST IN HIS OR HER FAVOR AT THE TIME OF EXECUTING THE RELEASE, WHICH IF KNOWN BY HIM MUST HAVE MATERIALLY AFFECTED HIS OR HER SETTLEMENT WITH THE DEBTOR." The permittee recognizes that by waiving the provisions of this section, Permittee will not be able to make any claims for damages that may exist, and to which, if known, would materially affect its decision to agree to these encroachments terms and conditions, regardless of whether Permittee's lack of knowledge is the result of ignorance, oversight, error, negligence, or any other cause;

12. The Permittee shall, and by the acceptance of these revocable permits agrees and promises:
  - a. to indemnify, defend, save and hold harmless the City of Oakland, its officers, agents, employees, and volunteers, to the maximum extent permitted by law, from any and all suits, claims, demands, liabilities, damages, actions, causes of action, penalties, fines, liens, judgments, costs, or expenses whatsoever (including, without limitation, attorneys' fees and costs) (collectively referred to as "claims"), whether direct or indirect, known or unknown, foreseen or unforeseen, brought by any person for or on account of any bodily injuries, disease or illness or damage to persons and/or property sustained or arising in the construction of the work performed under the permit or arising out of the Permittee's failure to perform the obligations with respect to the use and occupancy of the public right-of-way by virtue of the permit, to the extent that such claims were either (1) caused by the Permittee, its agents, employees, contractors or representatives, or (2) in the case of environmental contamination, the claim is a result of environmental contamination that emanates or emanated from the encroachment site, or was otherwise caused by the Permittee, its agents, employees, contractors or representatives; and
  - b. if any contamination is discovered below or in the immediate vicinity of the encroachments, and the contaminants found are of the type used, housed, stored, processed or sold on the properties, such shall amount to a rebuttable presumption that the contamination below, or in the immediate vicinity of, the encroachments were caused by the Permittee, its agents, employees, contractors or representatives; and
  - c. Permittee shall comply with all applicable federal, state, county and local laws, rules, and regulations governing the installation, maintenance, operation and abatement of the encroachments;
13. The encroachment permit and accompanying indenture agreements shall take effect when all the conditions hereinabove set forth shall have been complied with to the satisfaction of the City Engineer, and shall become null and void upon the failure of the Permittee to comply with all conditions;

14. The indenture agreement alone does not allow work to be done which requires permitting and/or inspection, and the Permittee shall obtain any and all required permits before beginning work;
15. The hereinabove conditions shall be binding upon the Permittee and the successive owners and assigns thereof; and be it

**FURTHER RESOLVED:** That the City Council, at its sole discretion and at a future date not yet determined, may impose additional and continuing fees as prescribed in the Master Fee Schedule, for use and occupancy of the public right-of-way; and be it

**FURTHER RESOLVED:** That this resolution shall take effect when all the conditions hereinabove set forth shall have been complied with to the satisfaction of the City Attorney and the City Engineer of the City of Oakland and shall become null and void upon the failure of the Permittee to comply with the conditions hereinabove set forth after notice and failure to cure such conditions in a reasonable manner; and be it

**FURTHER RESOLVED:** That the City Engineer is hereby directed to file a certified copy of this resolution for recordation with the Office of the Alameda County Clerk-Recorder as an encumbrance of the title of the property identified above without returning to Council.

IN COUNCIL, OAKLAND, CALIFORNIA, \_\_\_\_\_

**PASSED BY THE FOLLOWING VOTE:**

AYES - BROOKS, CAMPBELL WASHINGTON, GALLO, GUILLEN, KALB, KAPLAN, REID, AND  
PRESIDENT GIBSON MCELHANEY

NOES -

ABSENT -

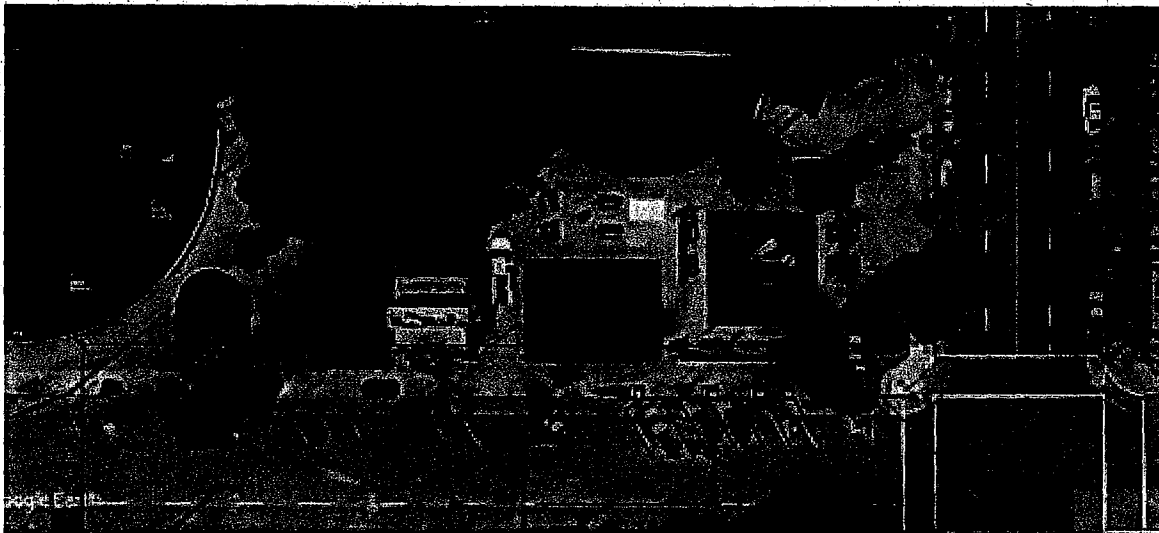
ABSTENTION -

ATTEST: \_\_\_\_\_  
LaTonda Simmons  
City Clerk and Clerk of the Council  
of the City of Oakland, California

Exhibit A: 10<sup>th</sup> Street near Jefferson Encroachment (4 pages)

**EXHIBIT A: 610 10TH STREET ENCROACHMENT (Page 1 of 4)**

**EVgo Site Layout – City of Oakland – Lafayette Park**



**Utility connection:  
Underground Transformer**

**EVgo Meter Pedestal  
(utility meter and distribution)**

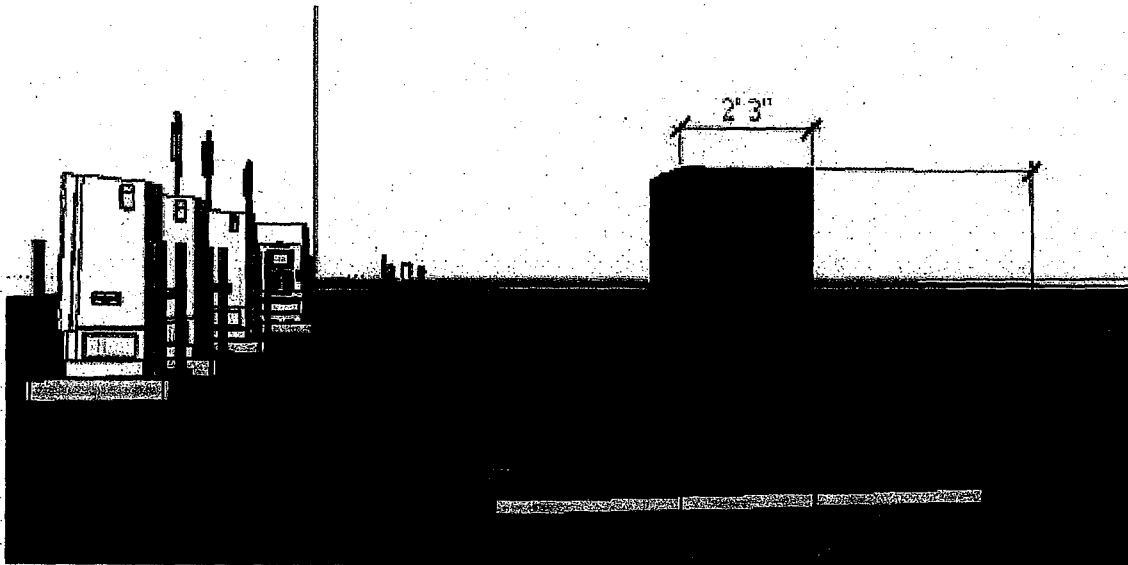


**(2) Public DC Fast Charging Stations  
(including 1 Van Accessible)**

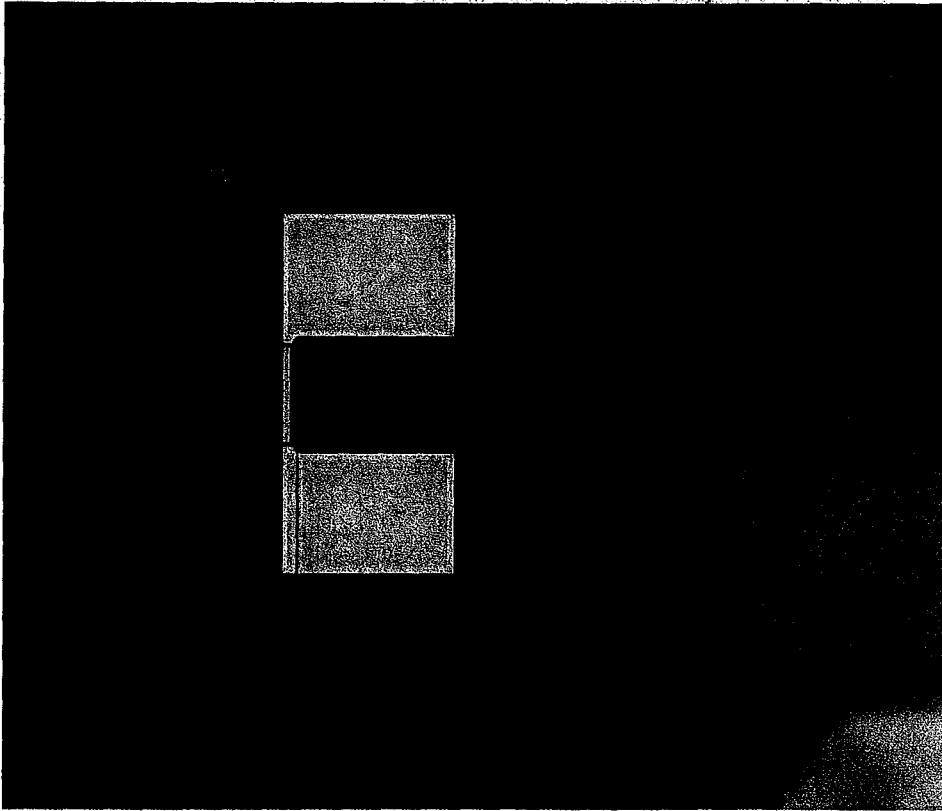
**(2) RideShare "Maven" DC Fast Charging Stations**

**EXHIBIT A: 610 10TH STREET ENCROACHMENT (Page 2 of 4)**

**Meter Pedestal Dimensions**

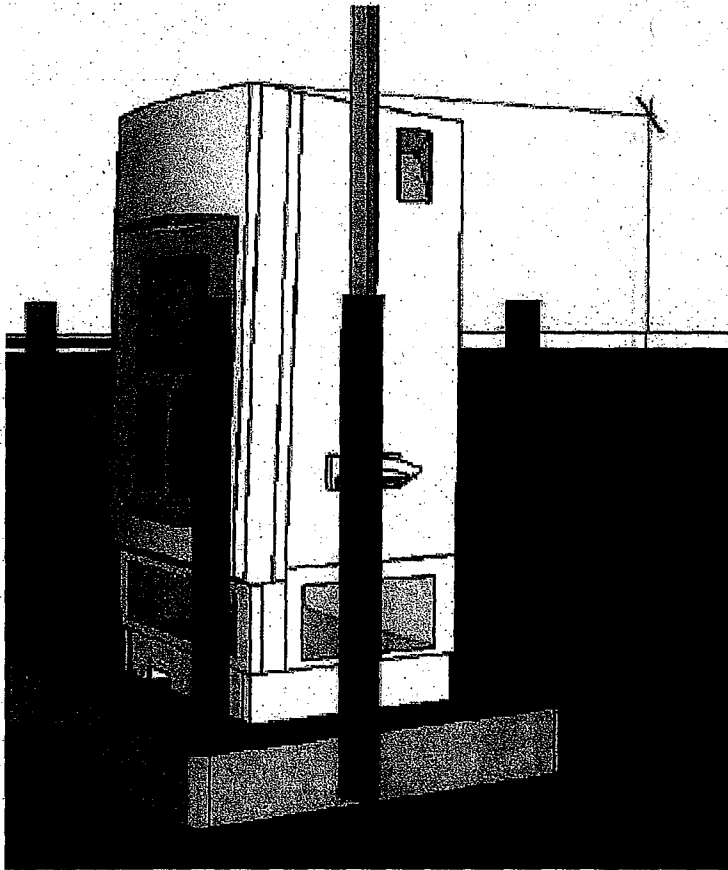
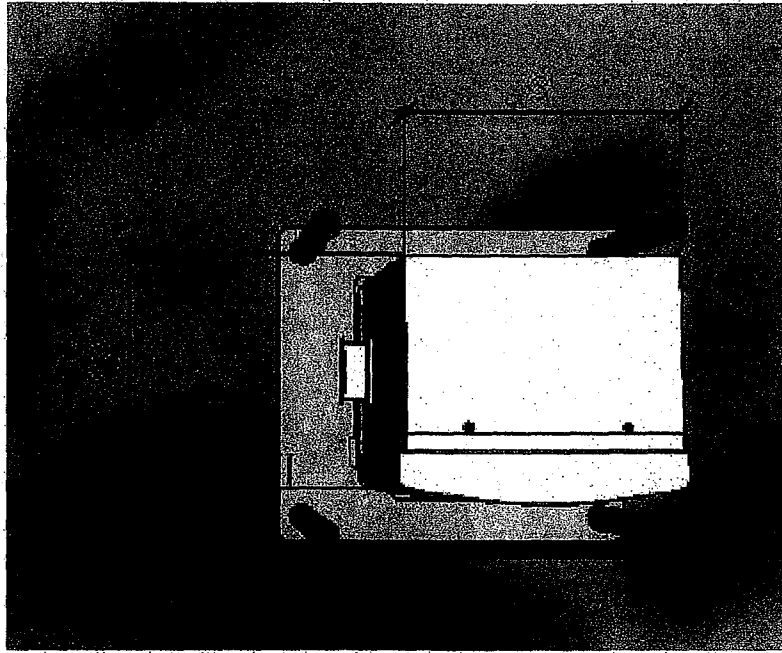


Required Clearance



**EXHIBIT A: 610 10TH STREET ENCROACHMENT (Page 3 of 4)**

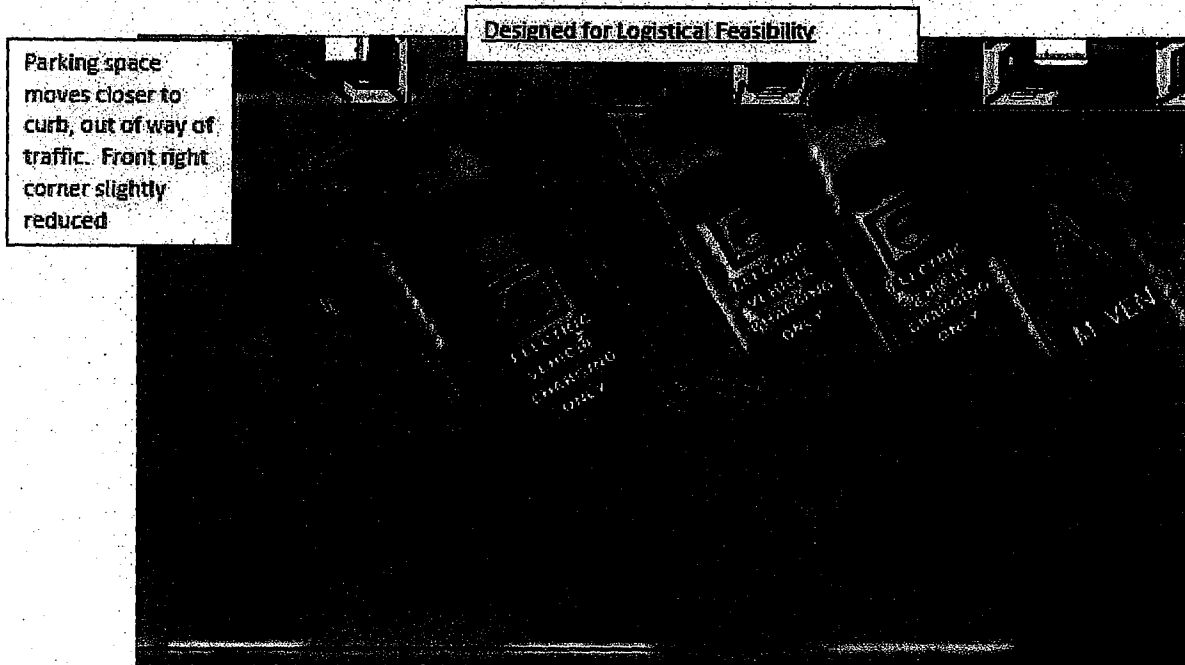
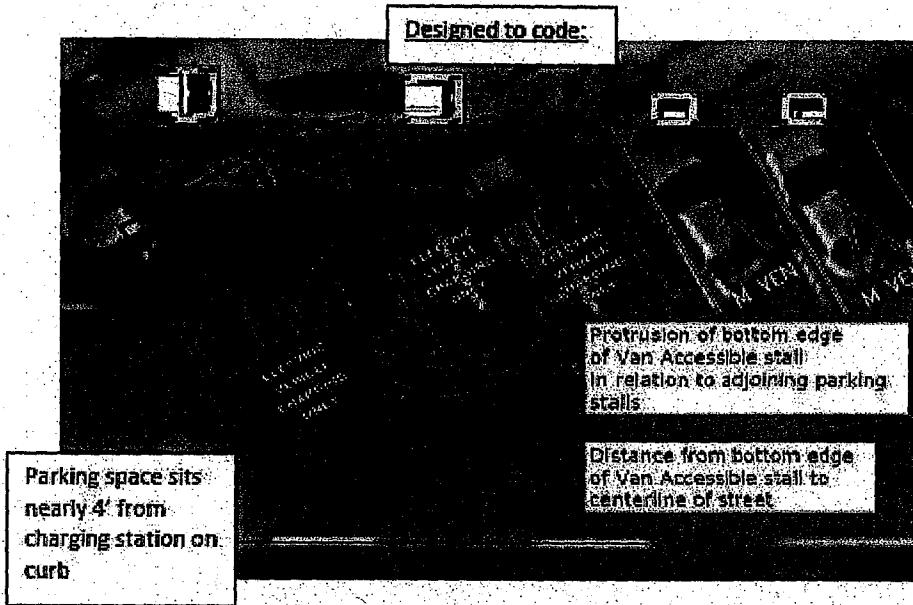
**Charging Station Dimensions**





**EXHIBIT A: 610 10TH STREET ENCROACHMENT (Page 4 of 4)**

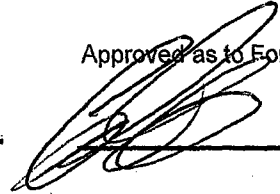
**Van Accessible Space Dimensions & Logistics**



2010 MAY 31 PM 4:33

Approved as to Form and Legality

OAKLAND CITY COUNCIL



City Attorney

RESOLUTION No. \_\_\_\_\_ C.M.S.

Introduced by Councilmember \_\_\_\_\_

**RESOLUTION GRANTING A CONDITIONAL AND REVOCABLE MAJOR ENCROACHMENT PERMIT TO EVGO TO ALLOW PORTIONS OF ELECTRIC VEHICLE CHARGING STATIONS AT LAKE PARK PARKING LOT TO ENCROACH ONTO THE PUBLIC RIGHT-OF-WAY ALONG 533 LAKE PARK AVENUE**

**WHEREAS**, EVgo (“Applicant”), a reputable plug-in electric vehicle (PEV) charging company that operates the largest public fast charging EV network in the nation with more than 1,000 charging stations, plans to install PEV charging stations at real property owned by the City Of Oakland, plans to file an application with the Department of Transportation for a Conditional and Revocable Encroachment Permit to allow portions of electric vehicle charging stations to encroach into the public right-of way along 533 Lake Park Avenue at Lake Park Lot; and

**WHEREAS**, the renderings limits of the encroachments are delineated in Exhibit A hereto and Incorporated herein; and

**WHEREAS**, the Applicant will apply for and secure Major Encroachment permit with the Department of Transportation for a conditional and revocable major encroachment for vehicle charging equipment to encroach into the public right of way. In addition, the applicant will prepare a complete Civil Engineering drawing for a permit (PX permit) with the department of transportation for any required improvement needed to public facilities including curb, gutter, sidewalk, roadway, and accessible ramps and access points. In addition, the applicant will apply for and secure Obstruction Permit(s) (OB permit) and excavation permit(s) (X permit) that may be needed for a complete installation of a fully functional vehicle charging station. Moreover, the applicant will apply for and secure utility permit from utility companies and building permits and electrical permits form the Building Departments that may be needed for a fully functioning electrical charging station; and

**WHEREAS**, staff has determined, based on review of the preliminary plans and investigation of the site of the encroachments, said encroachments in the public right-of-way and their location will not interfere with public use of the roadway, sidewalk, buried utilities, and will not endanger the public welfare and convenience during said public use; and

**WHEREAS**, each as a separate and independent basis, this action is exempt from the California Environmental Quality Act ("CEQA") pursuant to CEQA Guidelines sections 15301 (existing facilities), 15183 (projects consistent with General Plan and Zoning), and 15061(b)(3) (no significant effect on the environment); and

**WHEREAS**, a bond or securities in the amount no less than the full value of the work as verified by the City Engineer be submitted to the City and/or secured in a manner satisfactory to the City for the City to return the area to its original or better conditions should the Applicant fail to perform its obligation under the Major Encroachment to keep the installation free from graffiti and in good functioning conditions or to remove the improvements upon revocation of the Major Encroachment by the City Council. The bond shall be maintained for the life of the encroachment; therefore be it

**RESOLVED:** That the City Council has reviewed all relevant documents relating to its grant of the encroachment permits that is the subject of this resolution; and be it

**FURTHER RESOLVED:** That the City Council finds and determines that the decision made hereby is made in conformance with the requirements of CEQA; and be it

**FURTHER RESOLVED:** That upon the satisfactory completion of the required work and close-out of construction permits, and upon testing and acceptance of all equipment, and upon posting of the bond for the life of the asset by the Applicant and upon the approval of the Major Encroachment permit by the Department of Transportation Director, the "Applicant" will be then considered a "Permittee"; and be it

**FURTHER RESOLVED:** That said major encroachment permits are hereby conditioned by the following special requirements:

1. This agreement may be voided and the associated permits for encroachments may be revoked at any time and for reasons including but not limited to preservation of public safety or failure on the part of the Permittee to maintain improvements, at the sole discretion of the City Council, expressed by resolution as being in the City's best interest, or the associated permit may be suspended at any time, at the sole discretion of the City Engineer, upon failure of the Permittee to comply fully and continuously with each and all of the conditions set forth herein and in the associated permits;
2. The Permittee hereby disclaims any right, title, or interest in or to any portion of the public right of way, including the sidewalk and street, and agrees that the encroachments are granted for an indeterminate period of time and that the use and occupancy by the Permittee of the public right of way is temporary and does not constitute an abandonment, whether expressed or implied, by the City of Oakland of any of its rights associated with the statutory and customary purpose and use of and operations in the public right-of-way;
3. The Permittee shall maintain fully in force and effect, at its own expense, at all times during the period for which the permit is in effect, good and sufficient public liability insurance and

property damage insurance, both including contractual liability, insuring the City of Oakland, its officers, agents, employees, and volunteers against any and all claims arising out of the existence of the encroachments in the public right-of-way, as respects liabilities assumed under this permit, in amounts for each occurrence as determined and approved by the City's Risk Manager. The policy shall contain an endorsement declaring the policy as primary coverage on said liabilities. The Permittee shall submit a written certificate of such insurance or copy of the policy to City Engineer showing that insurance is in effect in compliance with this section, and shall file subsequent notices of the renewal thereof with the City Engineer. Such certificate shall state that the insurance coverage shall not be canceled, amended or be permitted to lapse without thirty (30) days prior written notice to City Engineer. The Permittee also agrees that the City Engineer, at his or her sole discretion, may review the type and amount of insurance required of the Permittee annually and may require the Permittee to increase the amount of and/or change the type of insurance coverage required, within reason and as circumstances warrant;

4. The Permittee shall be solely and fully liable and responsible for the repair, replacement, removal, reconstruction, and maintenance of any portion or all of the private improvements constructed or installed in the public right-of-way, whether by cause, neglect, or negligence of the Permittee or others, and for the associated costs and expenses necessary to restore or remove the encroachments to the satisfaction of the City Engineer, and shall not allow the encroachments to become a blight or a menace or a hazard to the health and safety of the general public;
5. The Permittee acknowledges and agrees that the encroachments are out of the ordinary and does not comply with City of Oakland standard installations. The Permittee further acknowledges and agrees that the City of Oakland and public utility agencies will periodically conduct work in the public right-of-way, including excavation, trenching, and relocation of its facilities, all of which may damage the encroachments. The Permittee further acknowledges and agrees that the City and public utility agencies take no responsibility for repair or replacement of the encroachments which may be damaged by the City or its contractors or public utility agencies or their contractors. The Permittee further acknowledges and agrees that upon notification by and to the satisfaction of the City Engineer, Permittee shall immediately repair, replace, or remove, at the sole expense of the Permittee, all damages to the encroachments that are directly or indirectly attributable to work by the City or its contractors or public utility agencies or their contractors. Notwithstanding the foregoing, this section may be subject to mutually agreed upon limitations;
6. The Permittee shall remain liable for and shall immediately reimburse the City of Oakland for all costs, fee assessments, penalties, and accruing interest associated with the City's notification and subsequent abatement action for required maintenance, repairs, or removal, whether in whole or in part, of the encroachments or of damaged City infrastructure made necessary by the failure, whether direct or indirect, of the Permittee to monitor the encroachments effectively and accomplish preventative, remedial, or restorative work expeditiously. The City reserves the unqualified right to collect all monies unpaid through any combination of available statutory remedies, including recordation of Prospective Liens

and Priority Liens/ Special Assessments with the Alameda County Recorder, inclusion of non-reimbursed amounts by the Alameda County Assessor with the annual assessment of the general levy, and awards of judgments by a court of competent jurisdiction;

7. Upon revocation of the either encroachment permit, the Permittee shall immediately, completely, and permanently remove the encroachment from the public right-of-way, repair any damage resulting therefrom, and restore the public right-of-way to its original conditions existing before the construction or installation of the encroachment, to the satisfaction of the City Engineer and all at the sole expense of the Permittee;
8. This agreement and the associated permits for the encroachments shall become effective upon filing of this agreement with the Alameda County Recorder for recordation as an encumbrance of the property and its title;
9. The Permittee acknowledges that the City makes no representations or warranties as to the conditions beneath said encroachment. By accepting this revocable permit. Permittee agrees that it will use the encroachment areas at its own risk, is responsible for the proper coordination of its activities with all other permittees, underground utilities, contractors, or workmen operating, within the encroachment areas and for the safety of itself and any of its personnel in connection with its entry under this revocable permit;
10. The Permittee acknowledges that the City is unaware of the existence of any hazardous substances in either encroachment areas, and Permittee hereby waives and fully releases and forever discharges the City and its officers, directors, employees, agents, servants, representatives, assigns and successors from any and all claims, demands, liabilities, damages, actions, causes of action, penalties, fines, liens, judgments, costs, or expenses whatsoever (including, without limitation, attorneys' fees and costs), whether direct or indirect, known or unknown, foreseen or unforeseen, that may arise out of or in any way connected with the physical condition or required remediation of the excavation area or any law or regulation applicable thereto, including, without limitation, the Comprehensive Environmental Response, Compensation and Liability Act of 1980, as amended (42 U.S.C. Sections 9601 et seq.), the Resource Conservation and Recovery Act of 1976 (42 U.S.C. Section 466 et seq.), the Safe Drinking Water Act (14 U.S.C. Sections 1401,1450), the Hazardous Waste Control Law (California Health and Safety Code Sections 25100 et seq.), the Porter-Cologne Water Quality Control Act (California Health and Safety Code Section 13000 et seq.), the Hazardous Substance Account Act (California Health and Safety Code Sections 253000 et seq.), and the Safe Drinking Water and Toxic Enforcement Act (California Health and Safety Code Section 25249.5 et seq.);
11. The Permittee further acknowledges that it understands and agrees that it hereby expressly waives all rights and benefits which it now has or in the future may have, under and by virtue of the terms of California Civil Code Section 1542, which reads as follows: "A GENERAL RELEASE DOES NOT EXTEND TO CLAIMS WHICH THE CREDITOR DOES NOT KNOW OR SUSPECT TO EXIST IN HIS OR HER FAVOR AT THE TIME OF EXECUTING THE RELEASE, WHICH IF KNOWN BY HIM MUST HAVE

MATERIALLY AFFECTED HIS OR HER SETTLEMENT WITH THE DEBTOR." The permittee recognizes that by waiving the provisions of this section, Permittee will not be able to make any claims for damages that may exist, and to which, if known, would materially affect its decision to agree to these encroachments terms and conditions, regardless of whether Permittee's lack of knowledge is the result of ignorance, oversight, error, negligence, or any other cause;

12. The Permittee shall, and by the acceptance of these revocable permits agrees and promises:
  - a. to indemnify, defend, save and hold harmless the City of Oakland, its officers, agents, employees, and volunteers, to the maximum extent permitted by law, from any and all suits, claims, demands, liabilities, damages, actions, causes of action, penalties, fines, liens, judgments, costs, or expenses whatsoever (including, without limitation, attorneys' fees and costs) (collectively referred to as "claims"), whether direct or indirect, known or unknown, foreseen or unforeseen, brought by any person for or on account of any bodily injuries, disease or illness or damage to persons and/or property sustained or arising in the construction of the work performed under the permit or arising out of the Permittee's failure to perform the obligations with respect to the use and occupancy of the public right-of-way by virtue of the permit, to the extent that such claims were either (1) caused by the Permittee, its agents, employees, contractors or representatives, or (2) in the case of environmental contamination, the claim is a result of environmental contamination that emanates or emanated from the encroachment site, or was otherwise caused by the Permittee, its agents, employees, contractors or representatives; and
  - b. if any contamination is discovered below or in the immediate vicinity of the encroachments, and the contaminants found are of the type used, housed, stored, processed or sold on the properties, such shall amount to a rebuttable presumption that the contamination below, or in the immediate vicinity of, the encroachments were caused by the Permittee, its agents, employees, contractors or representatives; and
  - c. Permittee shall comply with all applicable federal, state, county and local laws, rules, and regulations governing the installation, maintenance, operation and abatement of the encroachments;
13. The encroachment permit and accompanying indenture agreements shall take effect when all the conditions hereinabove set forth shall have been complied with to the satisfaction of the City Engineer, and shall become null and void upon the failure of the Permittee to comply with all conditions;
14. The indenture agreement alone does not allow work to be done which requires permitting and/or inspection, and the Permittee shall obtain any and all required permits before beginning work;

15. The hereinabove conditions shall be binding upon the Permittee and the successive owners and assigns thereof; and be it

**FURTHER RESOLVED:** That the City Council, at its sole discretion and at a future date not yet determined, may impose additional and continuing fees as prescribed in the Master Fee Schedule, for use and occupancy of the public right-of-way; and be it

**FURTHER RESOLVED:** That this resolution shall take effect when all the conditions hereinabove set forth shall have been complied with to the satisfaction of the City Attorney and the City Engineer of the City of Oakland and shall become null and void upon the failure of the Permittee to comply with the conditions hereinabove set forth after notice and failure to cure such conditions in a reasonable manner; and be it

**FURTHER RESOLVED:** That the City Engineer is hereby directed to file a certified copy of this resolution for recordation with the Office of the Alameda County Clerk-Recorder as an encumbrance of the title of the property identified above without returning to Council.

IN COUNCIL, OAKLAND, CALIFORNIA, \_\_\_\_\_

**PASSED BY THE FOLLOWING VOTE:**

AYES - BROOKS, CAMPBELL WASHINGTON, GALLO, GUILLEN, KALB, KAPLAN, REID, AND  
PRESIDENT GIBSON MCELHANEY

NOES -

ABSENT -

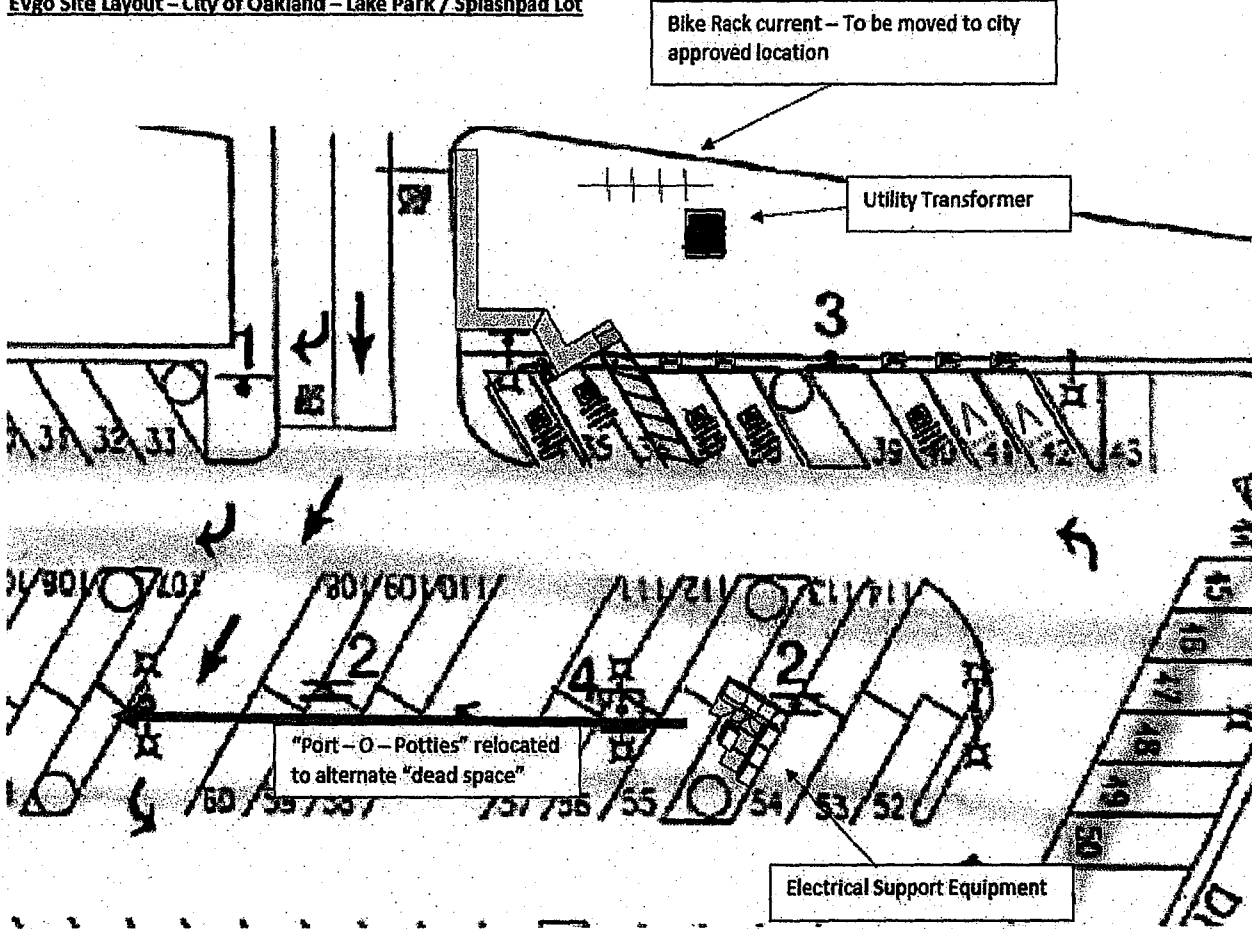
ABSTENTION -

ATTEST: \_\_\_\_\_  
LaTonda Simmons  
City Clerk and Clerk of the Council  
of the City of Oakland, California

Exhibit A: 533 Lake Park Ave Encroachment (5 pages)

**EXHIBIT A: 533 LAKE PARK AVENUE ENCROACHMENT (Page 1 of 5)**

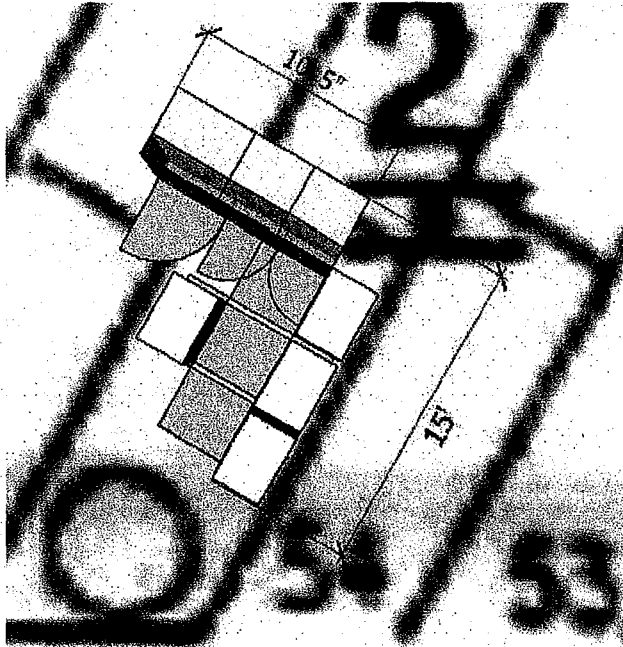
EVgo Site Layout - City of Oakland - Lake Park / Splashpad Lot



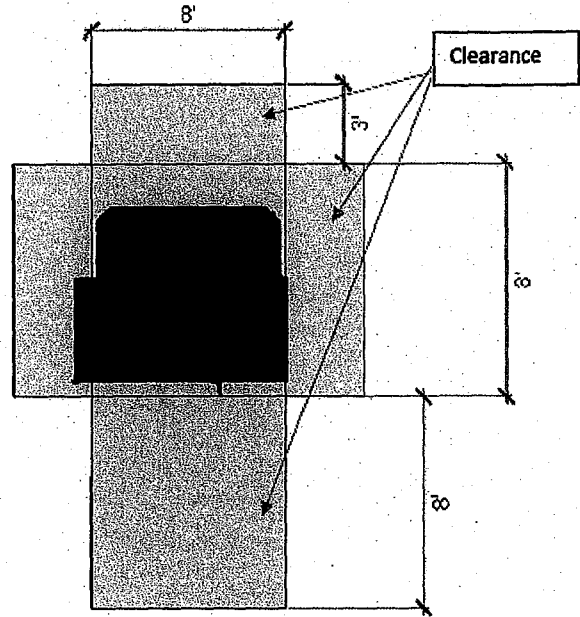


**EXHIBIT A: 533 LAKE PARK AVENUE ENCROACHMENT (Page 2 of 5)**

**Electrical Support Equipment & Transformer**



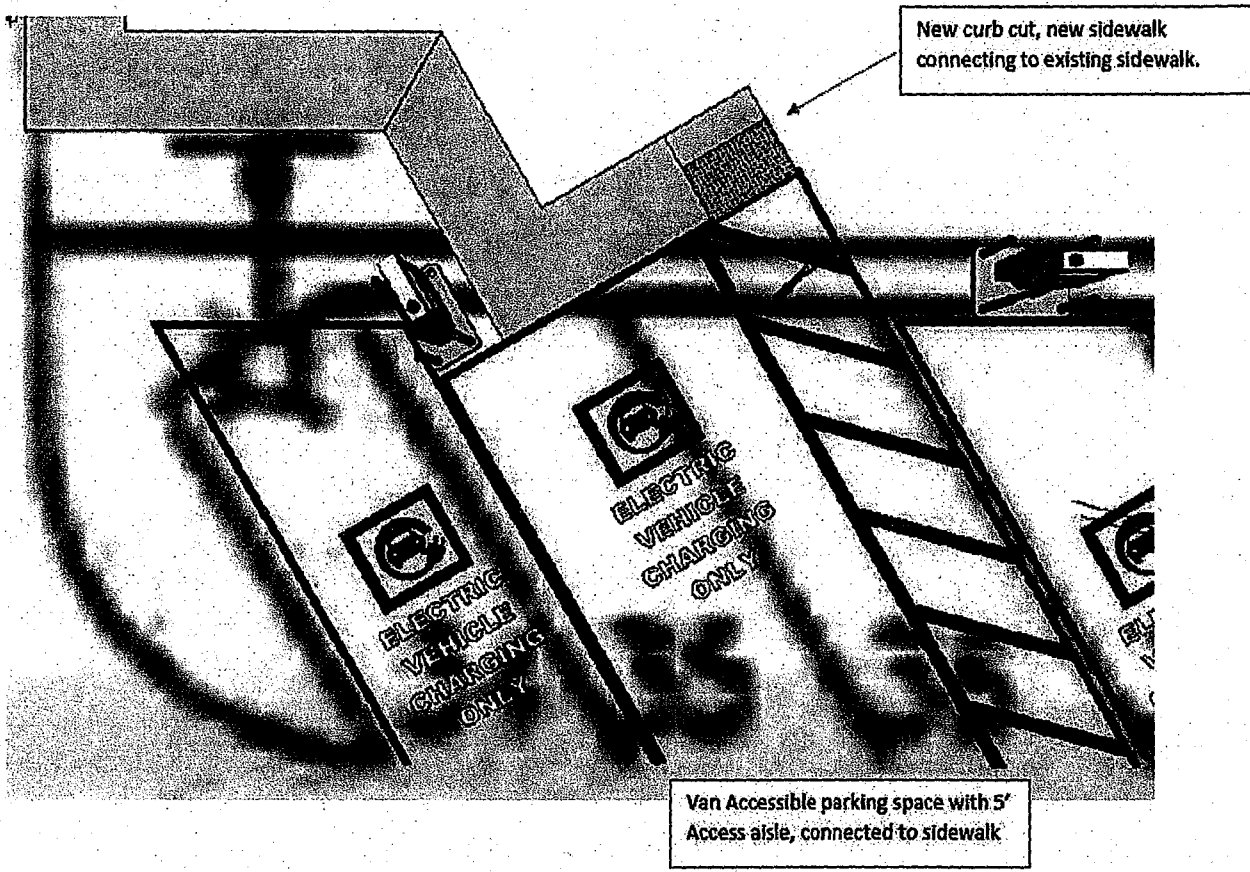
Switchgear, distribution, meter section and modular power cabinets



Utility Transformer

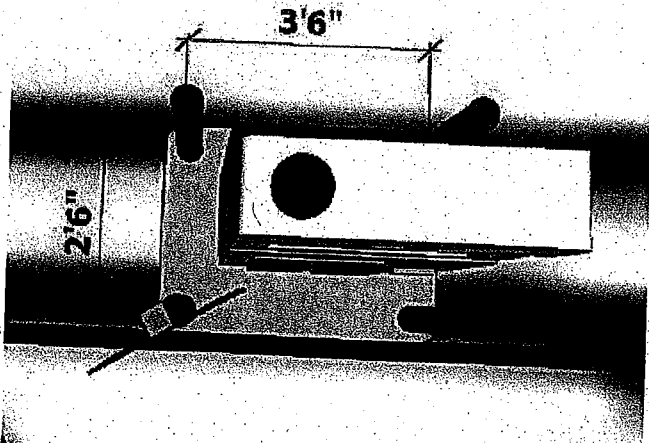
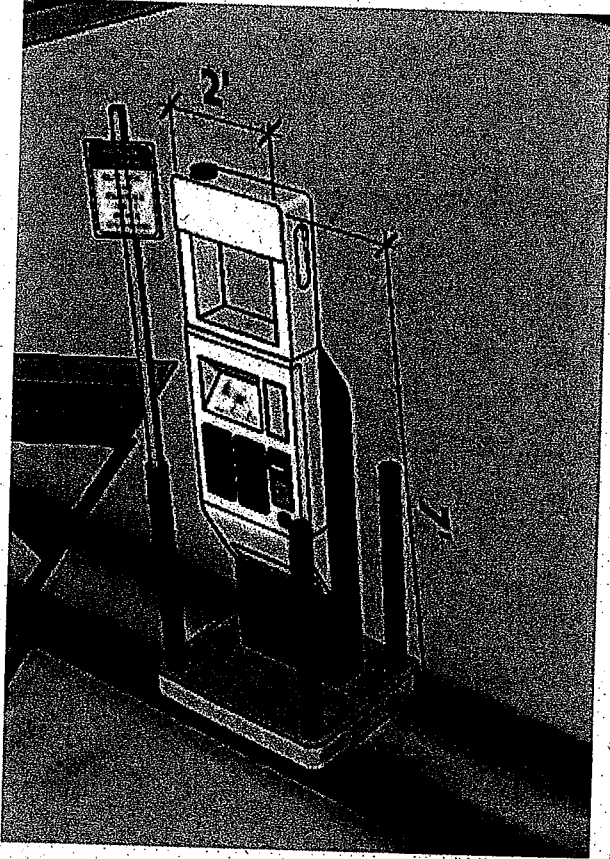
**EXHIBIT A: 533 LAKE PARK AVENUE ENCROACHMENT (Page 3 of 5)**

**Accessible Compliance**



**EXHIBIT A: 533 LAKE PARK AVENUE ENCROACHMENT (Page 4 of 5)**

**Charging Station Dimensions (High Power Charging Station Dispenser)**



**EXHIBIT A: 533 LAKE PARK AVENUE ENCROACHMENT (Page 5 of 5)**

**Charging Station Layout**

