

FILED
THE CITY CLERK
OAKLAND

CITY OF OAKLAND
2019 APR 11 PM 6:06

AGENDA REPORT

TO: Sabrina B. Landreth
City Administrator

FROM: Ryan Russo
Director, DOT

SUBJECT: Major Encroachment Permit at
392 11th Street

DATE: March 19, 2019

City Administrator Approval

Date: 4/11/19

RECOMMENDATION

Staff Recommends That The City Council Approve A Resolution Granting A Conditional And Revocable Major Encroachment Permit To NDO Group, LLC, To Allow Portions Of Existing Basement And Sidewalk Vault At 392 11th Street To Encroach Into The Public Right-Of-Way Along Franklin Street And 11th Street, Major Encroachment Permit ENMJ17061.

EXECUTIVE SUMMARY

Approval of this resolution will authorize the Director of the Department of Transportation (DOT) or the City Administrator or designee to issue a conditional and revocable Major Encroachment Permit to document and regulate existing encroachments in the public right-of-way at 392 11th Street.

Approximately 1,850 square feet of habitable space encroach into the public right-of-way. Encroachments in this permit are for the building elements extending into the public right-of-way beyond the limits allowed in the Oakland Building Code (section 15.04.3.2285). Building elements include sidewalk vault and basement extending twelve feet six inches below ground into the public right-of-way along Franklin Street and 11th Street.

The encroachment permit requires the property owner to comply with the conditions of approval issued by the Planning and Building Department. The Encroachments do not currently impact the use of the sidewalk fronting the property nor do they obstruct the path of travel for pedestrians or persons with disabilities. The encroachments are described in more detail in **Exhibit A** to the Resolution.

BACKGROUND / LEGISLATIVE HISTORY

Oakland Municipal Code (OMC) Chapter 12.08 requires a major encroachment permit for building elements into the public right-of-way as stated in the OMC Section 15.04.3.2285 for revisions to the California Building Code (CBC) Section 3202 and for encroachments that will

Item: _____
Public Works Committee
April 23, 2019

exceed those limits. The Building Department has issued a building permit to perform seismic and structural retrofitting in existing basement (permit number B1700103) subject to City's approval of the property owner's request for a revocable Major Encroachment Permit for existing encroachments. Encroachments comply with the OMC and follow the conditions of approval by the Planning and Building Department.

ANALYSIS AND POLICY ALTERNATIVES

Exhibit B to the Resolution is the Indenture Agreement to be executed between the City and Permittee, which sets out the conditions and obligations of the revocable Major Encroachment Permit. This Permit and the Indenture Agreement will hold the property owners liable and responsible for private improvements constructed in the public right-of-way and allows for maintenance of encroachments.

The Major Encroachment Permit includes an agreement allowing the City to revoke the Permit if in the City's best interest and require the property owners to remove the encroachments and restore the public right-of-way. Because the Permit authorizes habitable space within the right-of-way, which in the future may need to be removed, the Indenture Agreement requires the property owners to record a Notice to Prospective Purchasers of the enclosed habitable space. In addition, Council may direct staff to include other conditions as the location and nature of the proposed encroachments may require for public health, safety and appearance.

Approximately 1,850 square feet of encroachments exist in the right-of-way.

The existing encroachments do not currently interfere with public use of the right-of-way or buried utilities and do not endanger the public welfare and convenience.

FISCAL IMPACT

There is no fiscal impact to the City associated with this Major Encroachment permit. Staff costs for processing the proposed encroachment permit are covered by fees established in the Master Fee Schedule and have been paid by the applicant.

PUBLIC OUTREACH / INTEREST

This item did not require special public outreach other than the required posting on the City's website.

COORDINATION

The Report and Resolution was coordinated with Planning and Building Department, Budget Bureau, and the Office of the City Attorney.

SUSTAINABLE OPPORTUNITIES

Economic –Major Encroachment Permit facilitates private development improving the overall economic conditions in Oakland.

Environmental – No significant impact on the environment is identified.

Social Equity – No significant impact on social equity is identified.

CEQA

The California Environmental Quality Act (“CEQA”) and the CEQA Guidelines exempt specific types of projects from environmental review. The following CEQA exemptions apply to this encroachment under CEQA Guidelines sections 15301 (existing facilities), 15183 (projects consistent with a Community Plan, General Plan, or Zoning), and 15061(b)(3) (no significant effect on the environment).

ACTION REQUESTED OF THE CITY COUNCIL

Resolution Granting A Conditional And Revocable Major Encroachment Permit To NDO Group, LLC, To Allow Portions Of Existing Basement And Sidewalk Vault At 392 11th Street To Encroach Into The Public Right-Of-Way Along Franklin Street And 11th Street, Major Encroachment Permit ENMJ17061.

For questions regarding this report, please contact Kevin Kashi, Engineering Design and Right-Of-Way Supervisor (510) 238-7116.

Respectfully submitted,

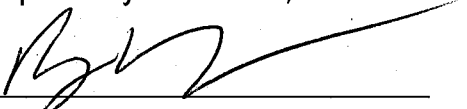

RYAN RUSSO
Director, Department of Transportation

Reviewed by:
Wladimir Wlassowsky, P.E., Assistant Director,
Department of Transportation

Reviewed by:
Mohamed Alaoui, P.E., Principal Civil Engineer,
Department of Transportation

Prepared and reviewed by:
Kevin Kashi, P.E., Supervising Civil Engineer,
Department of Transportation

Item: _____
Public Works Committee
April 9, 2019

OAKLAND CITY COUNCIL

DRAFT

City Attorney

2019 APR 11 PM 6:06

RESOLUTION No. _____ C.M.S.

Introduced by Councilmember _____

RESOLUTION GRANTING A CONDITIONAL AND REVOCABLE MAJOR ENCROACHMENT PERMIT TO NDO GROUP, LLC, TO ALLOW PORTIONS OF EXISTING BASEMENT AND SIDEWALK VAULT AT 392 11TH STREET TO ENCROACH INTO THE PUBLIC RIGHT-OF-WAY ALONG FRANKLIN STREET AND 11TH STREET, MAJOR ENCROACHMENT PERMIT ENMJ17061.

WHEREAS, NDO Group, LLC ("Permittee"), is the owner of the real property known as 392 11th Street and described in a Grant Deed Recorded April 1, 2016, by the Alameda County Clerk-Recorder and identified by the Alameda County Assessor as APN: 002-0057-018 and commonly known as 392 11th Street hereto and incorporated herein (the "Property"); and

WHEREAS, Permittee owns an existing Single Room Occupancy hotel on the property that was constructed in 1913-1914 and a portion of the existing basement and sidewalk vault is encroaching below ground into the right-of-way; and

WHEREAS, the existing basement and sidewalk vault encroach into the public right-of-way controlled by the City approximately 1,850 square feet, the limits of which encroachment are delineated on *Exhibit A* hereto and incorporated herein (the "Encroachments"); and

WHEREAS, the City approved a building permit for voluntary seismic retrofits in the basement (B1700103), and informed Permittee a conditional and revocable major encroachment permit for the Encroachments were necessary to continue to maintain the Encroachments; and

WHEREAS, Permittee has filed an application with Department of Transportation for such conditional and revocable Major Encroachment Permit (ENMJ17061) (hereinafter referred to as the "Permit"); and

WHEREAS, staff has determined, in accordance with the Oakland Municipal Code Chapter 12.08 and based on review of the plans and investigation of the Property and the area of the proposed Encroachments, that the Encroachments in the public right-of-way and their location will not, currently understood, interfere with the public use of the roadway, sidewalk, buried utilities, and will not endanger the public welfare and convenience during said public use; and

WHEREAS, each as a separate and independent basis, this action is exempt from the California Environmental Quality Act ("CEQA") pursuant to CEQA Guidelines sections 15301(existing facilities), 15183 (projects consistent with General Plan and Zoning), and 15061(b)(3) (no significant effect on the environment); now, therefore, be it

RESOLVED: That the City Council has reviewed all relevant documents relating to its grant of

RESOLVED: That the City Council has reviewed all relevant documents relating to its grant of the encroachment permit that is the subject of this resolution; and be it

FURTHER RESOLVED: That the City Council finds and determines that the decision made hereby is made in conformance with the requirements of CEQA; and be it

FURTHER RESOLVED: That the City Council hereby grants to the Permittee a conditional revocable Permit to allow the Encroachments, which Permit shall take effect only upon the City and Permittee entering into an Indenture Agreement in the form substantially attached hereto as **Exhibit B** (the "Indenture Agreement"), the conditions therein being incorporated into the Permit; and be it

FURTHER RESOLVED: That the Permit shall commence and continue in effect so long as Permittee satisfies, and continues to satisfy, all conditions and obligations set forth in the Indenture Agreement; and be it

FURTHER RESOLVED: That the City Council, at its sole discretion and at a future date not yet determined, may impose additional and continuing fees for use and occupancy of the public right-of-way; and be it

FURTHER RESOLVED: That the Permit authorized by this Resolution shall take effect when all the conditions and obligations set forth in the Indenture Agreement shall have been complied with to the satisfaction of the City Attorney and the City Engineer of the City of Oakland and shall become null and void upon the failure of the Permittee to comply with the conditions and obligations set forth in the Indenture Agreement, subject to the notice and cure provisions set forth therein, or upon a termination by resolution of the City Council as being in the City's best interest; and be it

FURTHER RESOLVED: That the City Engineer is hereby directed to file a certified copy of this Resolution for recordation with the Office of the Alameda County Clerk-Recorder as an encumbrance of the title of the property identified above.

IN COUNCIL, OAKLAND, CALIFORNIA, _____, 2019

PASSED BY THE FOLLOWING VOTE:

AYES - FORTUNATO BAS, GALLO, GIBSON MCELHANEY, KALB, REID, TAYLOR, THAO AND PRESIDENT KAPLAN

NOES -

ABSENT -

ABSTENTION -

ATTEST: _____

LaTonda Simmons
City Clerk and Clerk of the Council
of the City of Oakland, California

Exhibit A: 392 11th Street Encroachment (1 page)
Exhibit B: Indenture Agreement (8 pages)

EXHIBIT A: 392 11TH STREET ENCROACHMENT

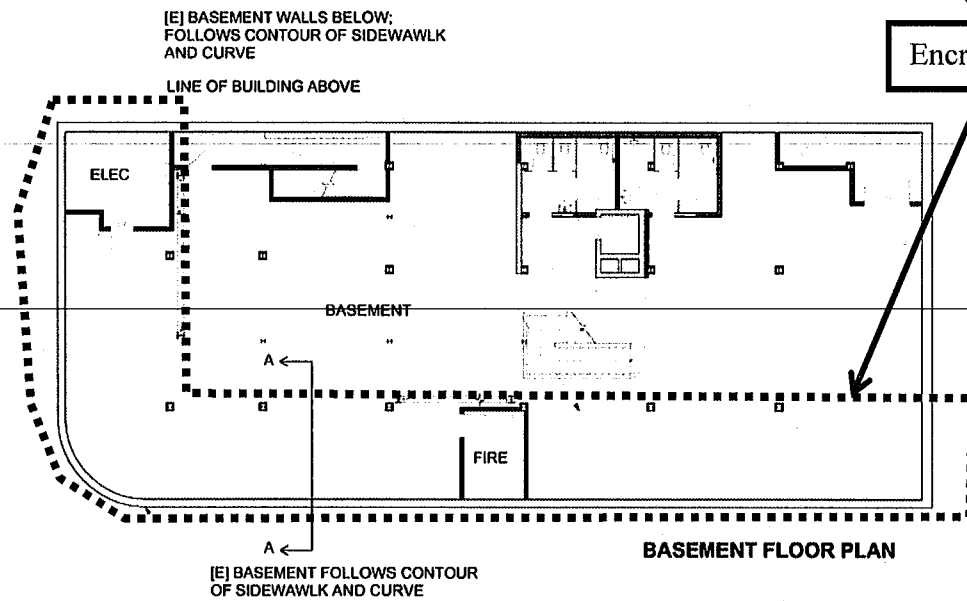
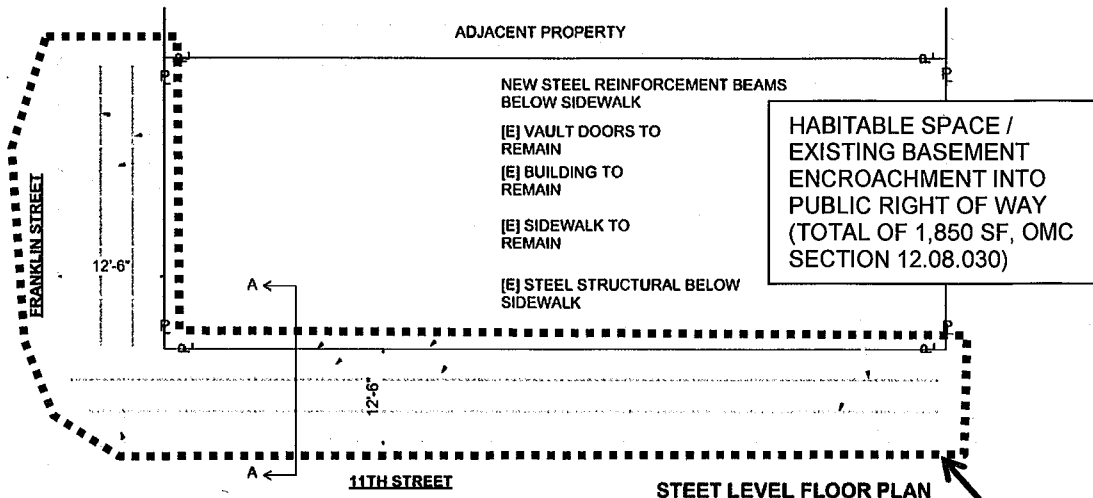

Encroachments

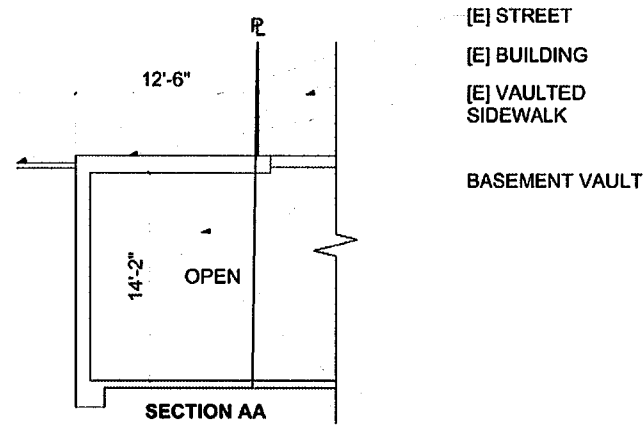

EXHIBIT B: INDENTURE AGREEMENT

(Attached Separately)

Recording requested by:
CITY OF OAKLAND
When recorded mail to:
City of Oakland
Public Works Department
Dalziel Admin Building
250 Ogawa Plaza - 4th Floor
Oakland, CA 94612
Attn: Director, DOT

----- space above for Recorder's use only -----

INDENTURE AGREEMENT

Address 392 11th Street

Permit no. ENMJ 17061

Parcel no. 002-0057-018

Authorities Municipal Code Section 12.08.080

Description Encroachments into the public right-of-way of existing sidewalk vault and existing basement along Franklin Street and 11th Street adjacent to 392 11th Street. Approximately 1,850 square feet of habitable space encroach below ground into the right-of-way.

RECITAL

The owner subscribed below of fee simple interest in the property referenced above and described in Exhibit B, attached hereto ("Property"), is hereby granted the revocable permit referenced above allowing the temporary encroachment described above and delineated in Exhibit C, attached hereto, and limiting the use, exercise, and operation of the encroachment with the requirements and restrictions set forth in Exhibit A, attached hereto, and the associated Major Encroachment Permit ("Permit"). The owner ("Permittee") agrees by and between themselves to be bound by the general and special conditions in Exhibit A and to comply with these conditions faithfully and fully at all times. The conditions of this Indenture Agreement and associated Permit shall equally bind all agents, heirs, successors, and assigns of the owner.

ACKNOWLEDGEMENT OF PROPERTY OWNER

(Notarization of Signature Required)

NDO Group, LLC, a California limited liability company

Signature _____

Date _____

Print Name _____

ATTACHMENTS

- Exhibit A - Conditions of encroachment
- Exhibit B - Description of privately owned parcel
- Exhibit C - Limits of encroachment
- Exhibit D - Oakland City Council Resolution _____ C.M.S.
- Exhibit E - Notice To Prospective Purchasers And/Or Tenants Of Enclosed Habitable Space In Right-Of-Way

CITY OF OAKLAND a municipal corporation WLAD WLASSOWSKY, P.E. Assistant Director Department of Transportation	by _____ date _____ BEN MOHAMED ALAOUI, P.E. Principal Civil Engineer Department of Transportation
---	--

EXHIBIT A

Conditions for the Encroachments in the Public Right-Of-Way

Address 392 11th Street

Parcel no. 002-0057-018

Permittee NDO Group, LLC, a California limited liability company

Permit no. ENMJ 17061

1. This Indenture Agreement will be automatically voided should (a) the associated Permit be revoked at any time and for any reason, at the sole discretion of the City Council, expressed by resolution, or (b) the associated Permit be suspended at any time, upon failure of the Permittee to comply fully and continuously with each and all of the general and special conditions set forth herein and in the associated Permit, as may be determined by the City Engineer in his or her sole discretion.
2. Upon revocation of the Permit, the Permittee shall immediately, completely, and permanently remove the Encroachments from the public right-of-way and restore the public right-of-way to its original conditions existing before the construction or installation of the encroachment, to the satisfaction of the City Engineer and all at the sole expense of the Permittee.
3. The Permittee does hereby disclaim any right, title, or interest in or to any portion of the public right-of-way, including the sidewalk and street, and agree that the use and occupancy by the Permittee of the public right-of-way is temporary and does not constitute an abandonment, whether expressed or implied, by the City of Oakland of any of its rights associated with the statutory and customary purpose and use of and operations in the public right-of-way.
4. The Permittee agrees to indemnify and save harmless the City of Oakland, its officers, agents, employees, and volunteers, and each of them, from any suits, claims, or actions brought by any person or persons, corporations, or other entities on account of (a) any bodily injury, disease, or illness, including death, damage to property, real or personal, or damages of any nature, however caused, and regardless of responsibility for negligence, arising in any manner out of the construction or installation of a private improvement itself or resulting from the Permittee's failure to maintain, repair, remove and/or reconstruct the private improvement, or (b) any title, ownership or authority issues arising from the existence of the Encroachments in the public right of way.
5. The Permittee shall maintain fully, in force and effect at all times that the Encroachments occupy the public right-of-way good and sufficient public liability insurance in a face amount not less than \$300,000.00 for each occurrence, and property damage insurance in a face amount not less than \$50,000.00 for each occurrence, both including contractual liability, insuring the City of Oakland, its officers, agents, employees, and volunteers against any and all claims arising out of the existence of the encroachment in the public right-of-way, as respects liabilities assume under this Permit, and that a certificate of such insurance and subsequent notices of the renewal thereof, shall be filed with the City Engineer of the City of Oakland, and that such certificate shall state that the insurance coverage shall not be canceled or be permitted to lapse without thirty calendar (30) days written notice to the City Engineer. The Permittee also agree that the City of Oakland may review the type and amount of insurance required of the Permittee annually and may require the Permittee to increase the amount of and/or change the type of insurance coverage required.
6. The Permittee shall be solely and fully liable and responsible for the repair, replacement, removal, reconstruction, and maintenance of any portion or all of the private improvements constructed or installed in the public right-of-way, whether by the cause, neglect, or negligence of the Permittee or others and for the associated costs and expenses necessary to restore or remove the encroachment to the satisfaction of

the City Engineer and shall not allow the Encroachments to become a blight or a menace or a hazard to the health and safety of the general public.

7. The Permittee acknowledges and agrees that the Encroachments are out of the ordinary and do not comply with City of Oakland standard installations. The Permittee further acknowledges and agrees that the City of Oakland and public utility agencies will periodically conduct work in the public right-of-way, including excavation, trenching, and relocation of its facilities, all of which may damage the encroachment. Permittee further acknowledges and agrees that the City and public utility agencies take no responsibility for repair or replacement of the Encroachments, which may be damaged by the City or its contractors or public utility agencies or their contractors. Permittee further acknowledge and agree that upon notification by and to the satisfaction of the City Engineer, Permittee shall immediately repair, replace, or remove, at the sole expense of the Permittee, all damages to the encroachment that are directly or indirectly attributable to work by the City or its contractors or public utility agencies or their contractors.
 8. Permittee shall remain liable for and shall immediately reimburse the City of Oakland for all costs, fee assessments, penalties, and accruing interest associated with the City's notification and subsequent abatement action for required maintenance, repairs, or removal, whether in whole or in part, of the encroachment or of damaged City infrastructure made necessary by the failure, whether direct or indirect, of the Permittees to monitor the encroachment effectively and accomplish preventative, remedial, or restorative work expeditiously. The City reserves the unqualified right to collect all monies unpaid through any combination of available statutory remedies, including recordation of Prospective Liens and Priority Liens/ Special Assessments with the Alameda County Recorder, inclusion of non-reimbursed amounts by the Alameda County Assessor with the annual assessment of the general levy, and awards of judgments by a court of competent jurisdiction.
-
9. The Permittee shall provide written notice, in the form attached hereto as **Exhibit E**, to all prospective purchasers and/or tenants of any enclosed habitable space subject to this Encroachment Permit, that the City may revoke or suspend this Permit and require the removal of such encroachments (the "Notice").
 10. The Permittee shall file this Indenture Agreement and the Notice to prospective purchasers and/or tenants with the Alameda County Recorder for recordation as encumbrances of the property and its title.
 11. That said Permittee acknowledges that the City makes no representations or warranties as to the conditions beneath said encroachment. By accepting this revocable Permit, Permittee agrees that it will use the encroachment area at its own risk, is responsible for the proper coordination of its activities with all other Permittee, underground utilities, contractors, or workmen operating, within the encroachment area and for the safety of itself and any of its personnel in connection with its entry under this revocable Permit.
 12. That said Permittee acknowledges that the City is unaware of the existence of any hazardous substances beneath the encroachment area, and Permittee hereby waives and fully releases and forever discharges the City and its officers, directors, employees, agents, servants, representatives, assigns and successors from any and all claims, demands, liabilities, damages, actions, causes of action, penalties, fines, liens, judgments, costs, or expenses whatsoever (including, without limitation, attorneys' fees and costs), whether direct or indirect, known or unknown, foreseen or unforeseen, that may arise out of or in any way connected with the physical condition or required remediation of the excavation area of any law or regulation applicable thereto, including, without limitation, the Comprehensive Environmental Response, Compensation and Liability Act of 1980, as amended (42 U.S.C. Sections 9601 et seq.), the Resource Conservation and Recovery Act of 1976 (42 U.S.C. Section 466 et seq.), the Safe Drinking Water Act (14 U.S.C. Sections 1401, 1450), the Hazardous Waste Control Law (California Health and Safety Code Sections 25100 et seq.), the Porter-Cologne Water Quality Control Act (California Health and Safety Code Section 13000 et seq.), the Hazardous Substance Account Act (California Health and Safety Code Sections 253000 et seq.), and the Safe Drinking Water and Toxic Enforcement Act (California Health and Safety Code Section 25249.5 et seq.).
 13. That said Permittee further acknowledges that it understands and agrees that it hereby expressly waives all

rights and benefits which it now has or in the future may have, under and by virtue of the terms of California Civil Code Section 1542, which reads as follows: "A GENERAL RELEASE DOES NOT EXTEND TO CLAIMS WHICH THE CREDITOR DOES NOT KNOW OR SUSPECT TO EXIST IN HIS FAVOR AT THE TIME OF EXECUTING THE RELEASE, WHICH IF KNOWN BY HIM MUST HAVE MATERIALLY AFFECTED HIS SETTLEMENT WITH THE DEBTOR."

14. That said Permittee recognizes that by waiving the provisions of this section, Permittee will not be able to make any claims for damages that may exist, and to which, if known, would materially affect its decision to agree to these encroachment terms and conditions, regardless of whether Permittee's lack of knowledge is the result of ignorance, oversight, error, negligence, or any other cause.
15. That said Permittee, by the acceptance of this revocable Permit, agrees and promises:
 - (a) To indemnify, defend, and hold harmless the City of Oakland, its officers, agents, and employees, to the maximum extent permitted by law, from any and all claims, demands, liabilities damages, actions, causes of action, penalties, fines, liens, judgments, costs, or expenses whatsoever (including, without limitation, attorneys' fees and costs; collectively referred to as "claims", whether direct or indirect, known or unknown, foreseen or unforeseen, to the extent that such claims were either (1) caused by the Permittee, its agents, employees, contractors or representatives, or, (2) in the case of environmental contamination, the claim is a result of environmental contamination that emanates or emanated from the 392 11th Street, Oakland, California site, or was otherwise caused by the Permittee, its agents, employees, contractors or representatives.
 - (b) That, if any contamination is discovered below or in the immediate vicinity of the encroachment, and the contaminants found are of the type used, housed, stored, processed or sold on or from the 392 11th Street, Oakland, California site, such shall amount to a rebuttable presumption that the contamination below, or in the immediate vicinity of, the encroachment was caused by the Permittee, its agents, employees, contractors or representatives.
 - (c) That said Permittee shall comply with all applicable federal, state, county and local laws, rules, and regulations governing the installation, maintenance, operation and abatement of the encroachment.
16. That this Indenture Agreement and associated Permit shall take effect when all the conditions hereinabove set forth shall have been complied with to the satisfaction of the City Engineer.
17. That this Indenture Agreement alone does not allow work to be done which requires permitting and/or inspection. The Permittee must obtain any and all required permits before beginning work.
18. The City, at its sole discretion and at future date not yet determined, may impose additional and continuing fees for use and occupancy of the public right-of-way.
19. Additional or continuing fees will apply in accordance with the City's Municipal Code, City standards, future plans for the right of way, and City practices to regulate the right of way for the public interest.
20. The rights and obligations of this Indenture Agreement shall be binding upon the Permittee, all successive owners and assigns thereof, and shall be automatically assigned to and assumed by any and all successive persons or entities with a fee interest in all or any portion of the Property.

EXHIBIT B

Description of the Private Property Abutting the Encroachment

Address 392 11th Street

Parcel no. 002-0057-018

Deed no. 2016078515

Recorded 04/01/2016

The land referred to is situated in the County of Alameda, City of Oakland, State of California, and is described as follows:

Beginning at a point formed by the intersection of the northern line of 11th Street with the eastern line of Franklin Street; running thence northerly along said eastern line of Franklin Street 37 feet, 6 inches; thence at right angles easterly 100 feet; thence at right angles southerly 37 feet, 6 inches to the northerly line of 11th Street and thence westerly along said last named line 100 feet to the point of beginning.

Being Lot 1, the southerly half of Lot 2 and the southern 37 feet 6 inches of Lot 28, in Block 160, as said lots and block are shown on Kellersberger's Map of the City of Oakland; on file in the office of the County Recorder of Alameda County.

APN: 002-0057-018

EXHIBIT C

Limits of the Encroachment in the Public Right-Of-Way

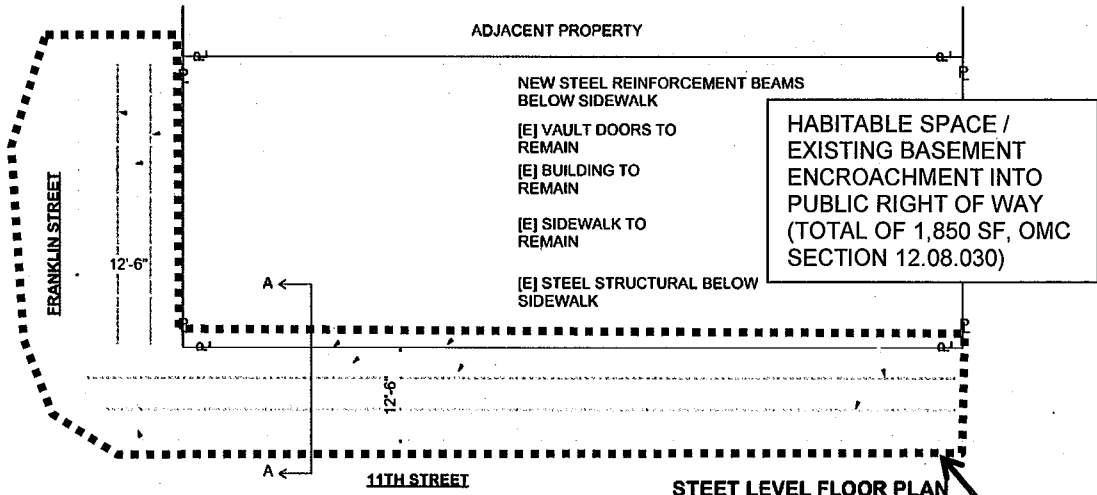

Encroachments

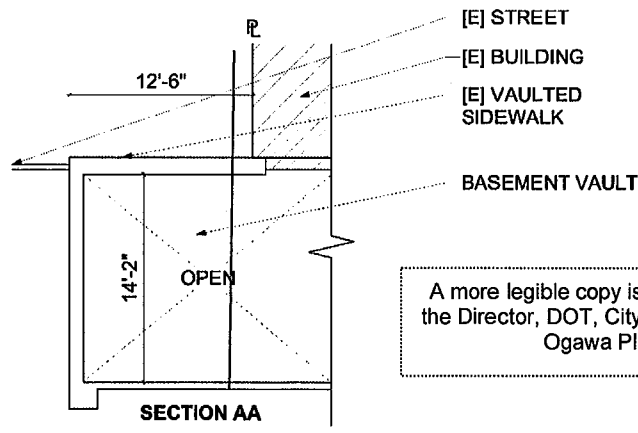
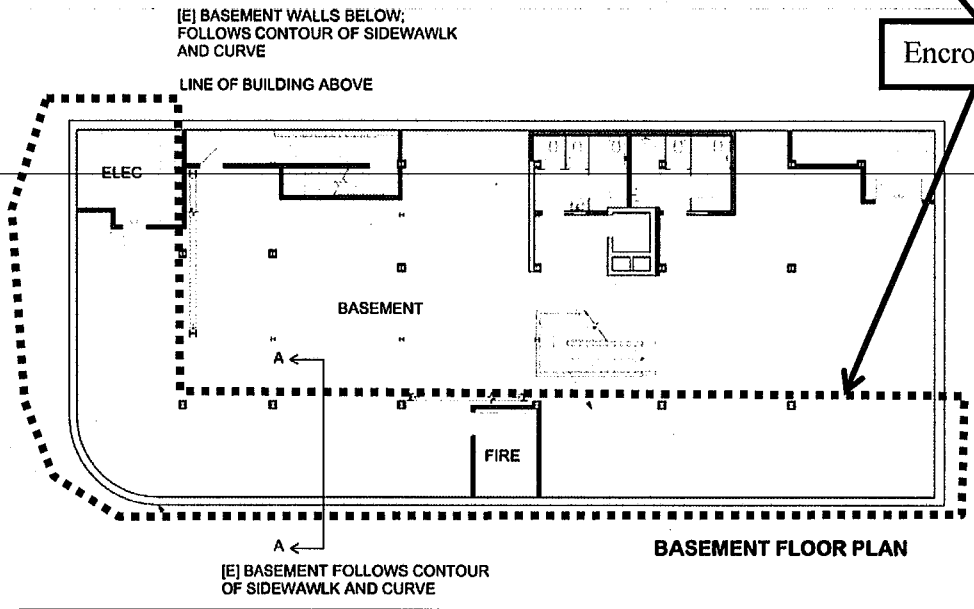

A more legible copy is available at the Office of
the Director, DOT, City of Oakland, 250 Frank H.
Ogawa Plaza, 4th floor.

EXHIBIT D

Oakland City Council Resolution _____ C.M.S. (page 1 reference)

A more legible copy is available at the Office of
the Director, DOT, City of Oakland, 250 Frank H.
Ogawa Plaza, 4th floor.

EXHIBIT E:

**FORM OF NOTICE TO PROSPECTIVE PURCHASERS AND/OR TENANTS OF
ENCLOSED HABITABLE SPACE IN RIGHT-OF-WAY AT 2401 BROADWAY**

Recording requested by:

CITY OF OAKLAND

When recorded mail to:

City of Oakland
Public Works Department
Dalziel Admin Building
250 Ogawa Plaza - 4th Floor
Oakland, CA 94612
Attn: Director, DOT

----- space above for Recorder's use only -----

Address 392 11th Street

Permit no. ENMJ 17061

Parcel no. 002-0057-018

Authorities Municipal Code Section 12.08.080

Description Encroachments into the public right-of-way of existing sidewalk vault and existing basement along Franklin Street and 11th Street adjacent to 392 11th Street. Approximately 1,850 square feet of habitable space encroach below ground into the right-of-way.

This property is subject to a conditional and revocable Major Encroachment Permit No. ENMJ 17061 for enclosed habitable space in the public right-of-way ("Encroachment Property"), authorized by City Council Resolution C.M.S. _____ on _____, 2019, and effective upon recordation of the accompanying Indenture Agreement between the City of Oakland and NDO Group, LLC, a California limited liability company ("Permittee") and satisfaction of all conditions therein.

The conditional and revocable Major Encroachment Permit and accompanying Indenture Agreement are binding on the Permittee, successive owners and assigns thereof, and on all successive persons or entities with a fee interest in all or any portion of the Encroachment Property. The conditions and requirements of said Major Encroachment Permit and accompanying Indenture Agreement are recorded with the Alameda County Recorder as encumbrances of the Encroachment Property and its title.

Prospective purchasers and tenants are hereby given notice that the City may revoke this Major Encroachment Permit and require removal of said Encroachments upon the terms and conditions set forth in the Indenture Agreement.